

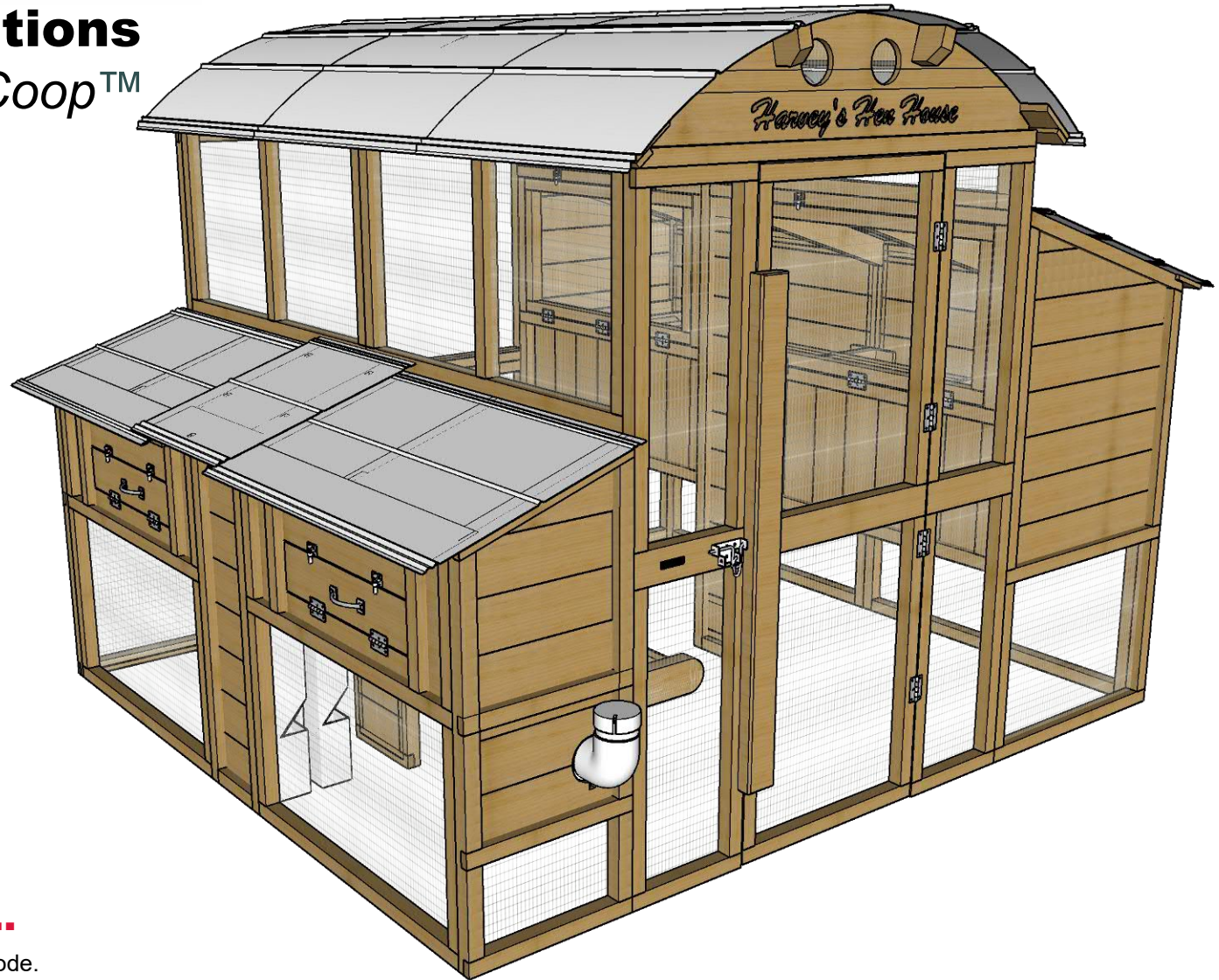

Assembly Instructions

Round-Top Walk-In Coop[™]

Model 2



These written instructions, as provided with your purchase, will always be the latest iteration of the instructions and match the coop shipped and provide the most complete up-to-date information.

We depend on feedback about our instructions to implement changes to future versions. Please know that we value your input to that ongoing process and endeavor to produce instructions that are as effective as possible for a wide variety of customers.



You Tube
Assembly
Overview...

Use your phones camera to read QR Code.
Video overview of assembly.

Front

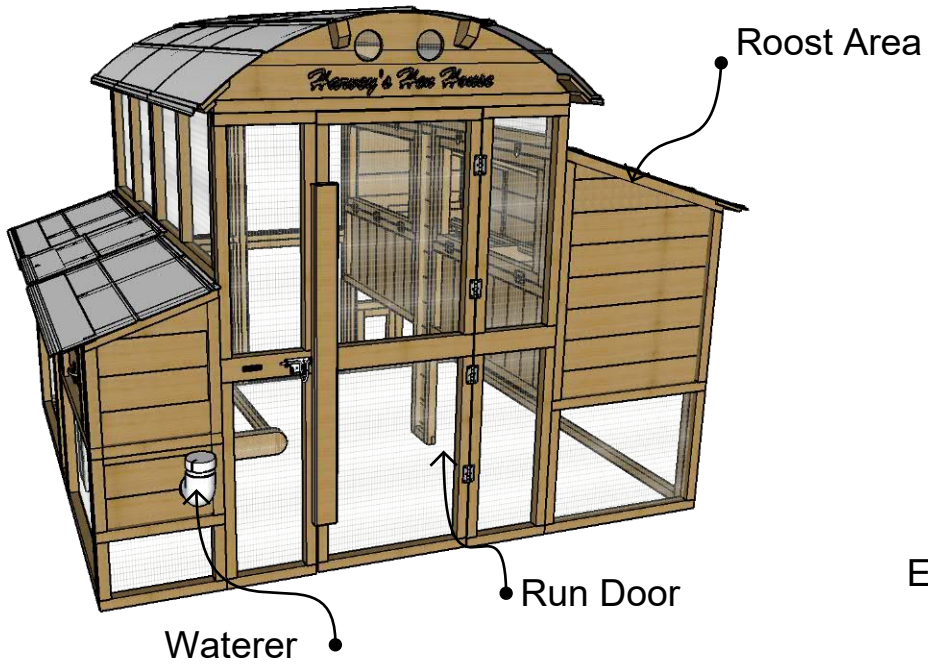

Left

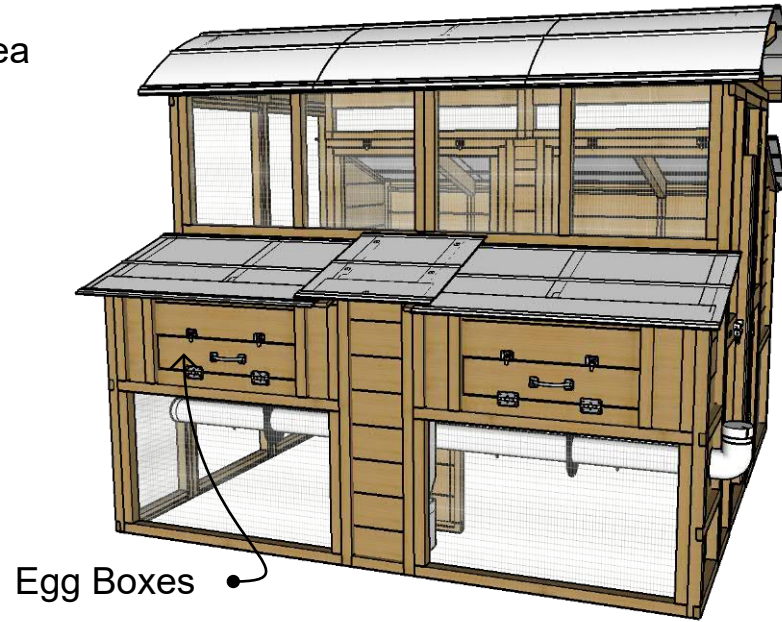

Run Roof

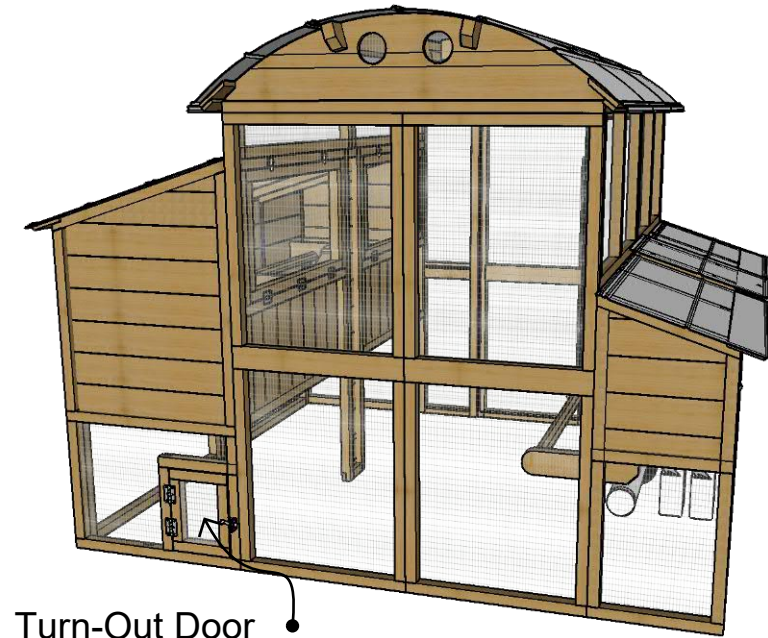
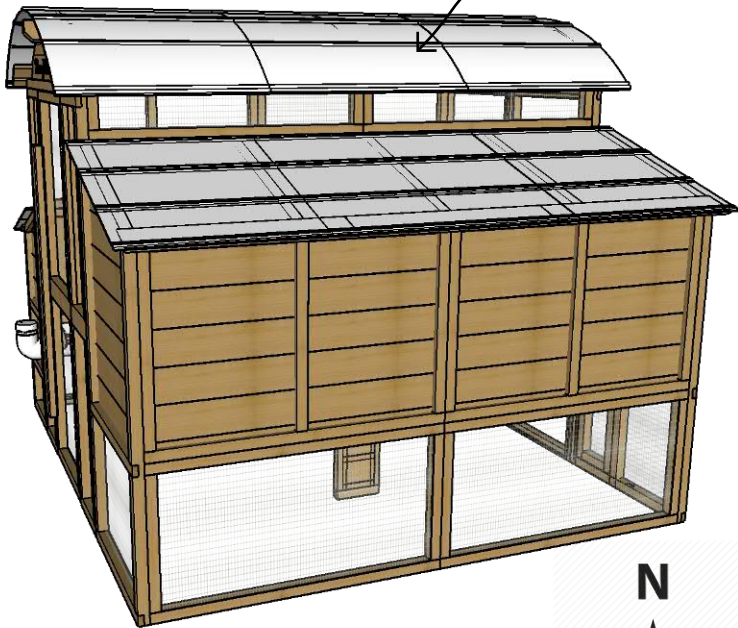

Right

We recommend having the right side of your coop facing North in winter weather intense locations.



Back



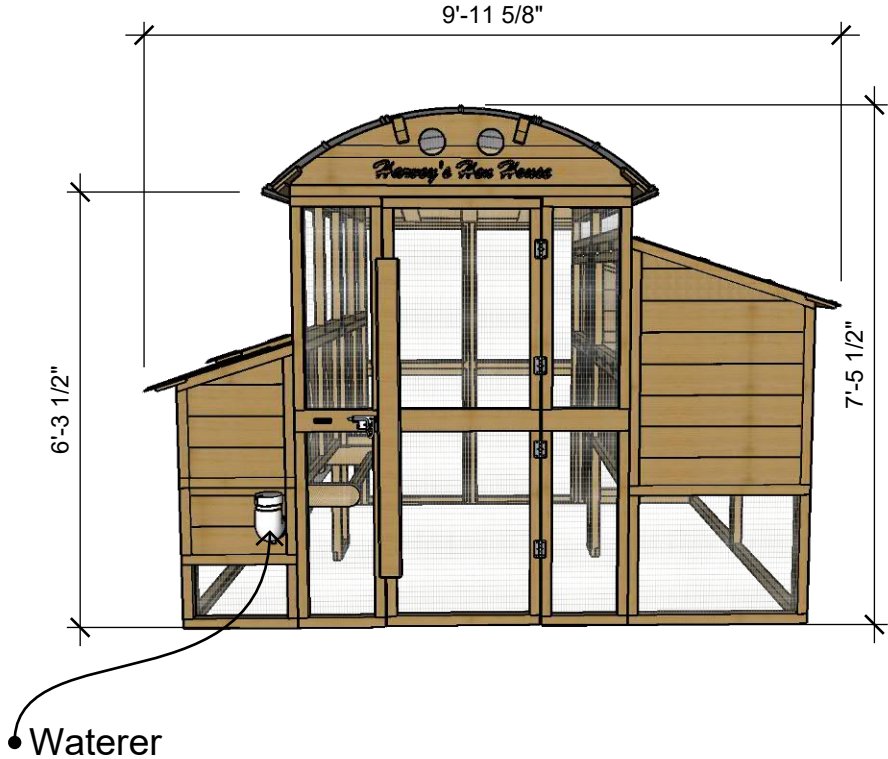
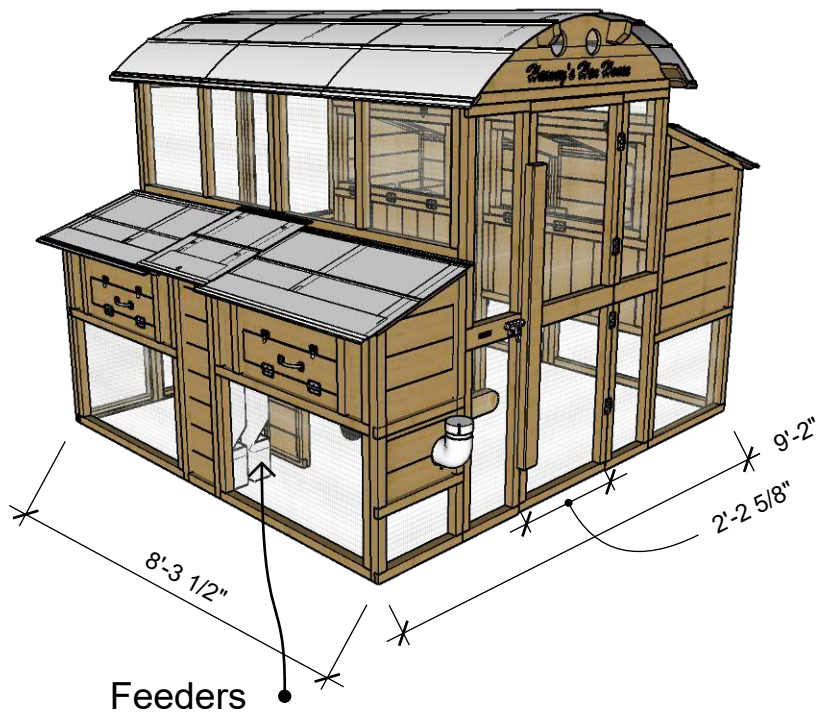

Exterior measurements are to the outside edges of the ground foot print.

Ground contact panels are 1 3/4 inches wide.

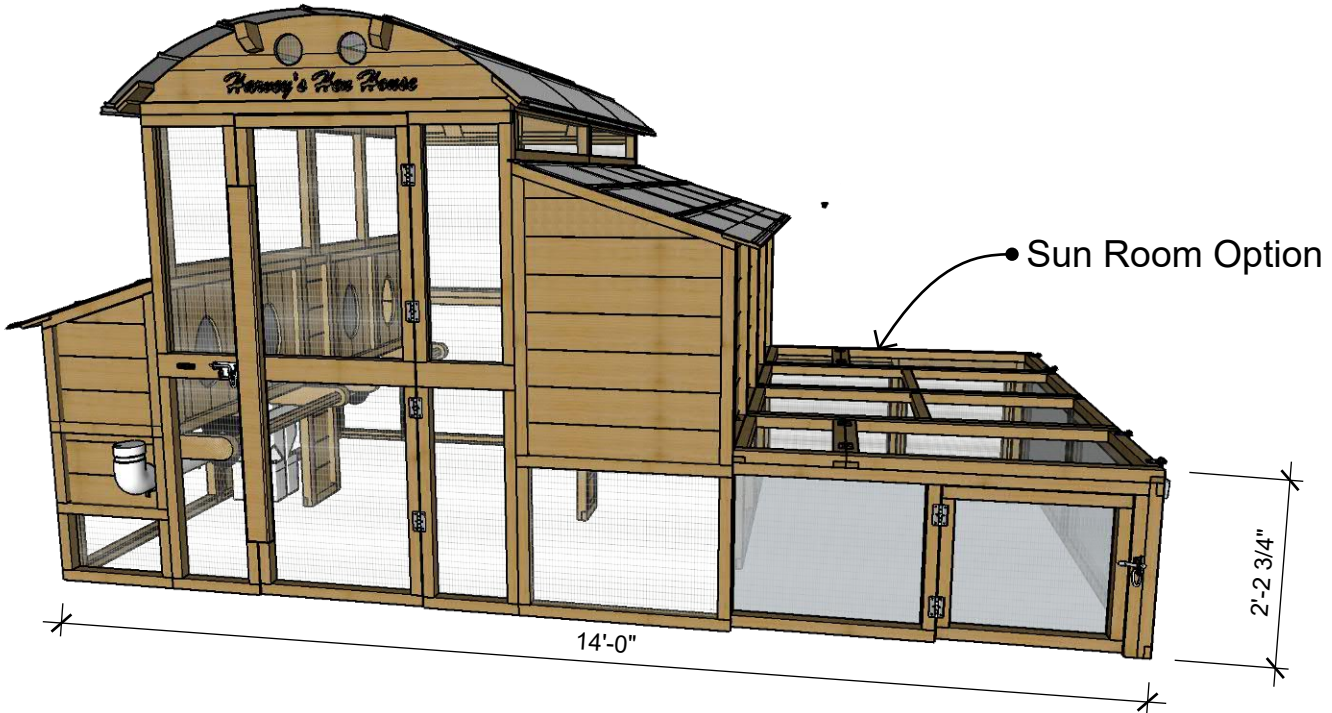

MADE IN **roost&root**
Find your inner farmer.™

Assembly Instructions
Round-Top Walk-In Coop
Model 2 V1 2022

Copyright © Roost & Root all rights reserved.

Overall Dimensions

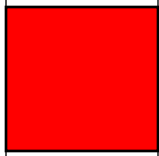



Sorry... a little reading ;-)

Understanding these concepts / conventions will help guide you through the instructions.

- 1 Mating edges of parts to be flush and tight (when called for) will keep measurements in tolerance as the coop grows in size.
- 2 **CRITICAL:** Having a flat area is required for the coop to assemble properly and operate properly.
- 3 We estimate about 12 man hours (a long day for 2 people) of ordinary skills to assemble. Two people are required for many steps.
- 4 You will need a drill (preferably cordless) a tape measure and a hammer. Everything else is provided.
- 5 Drive screws only deep enough to hold parts tight and not bury the heads too deeply as water can sit in the divots and it may cause softening of the wood and prematurely loosen screws. It will also greatly decrease your ability to easily disassemble a part if needed.
- 6 You may end up directly driving in a screw. The provided screws are very aggressive and can drive with no pre-drilled hole or you can preferably use the provided pilot countersink bit. Keep screw entry points in the meat of the wood and not too close to edges. Screws in knots or close to edges should for sure be pre-drilled.
- 7 Rough Cedar may have knots, cracks or frays that are normal. We cull and cut around most imperfections we deem structurally problematic during fabrication. If you get a piece that you feel is not beautiful, please let us know so we can address your concern.
- 8 We hand fabricated your coop with human carpenters. We work really hard to not make mistakes. On the rare occasion that we either misfabricated a part, a part was damaged in shipping, or we forgot to package a needed part, contact us and we will ship out a replacement part for you at no cost.
- 9 We recommend dirt floors in the runs of coops. A trimmed rubber mat can be placed in the bottom of egg boxes and you may wish to put pine shavings or shredded junk mail in them. They are left wire so they can be cleaned in the event of a broken egg.

Sealing & Care:

We recommend you leaving your coop natural. You can stain your coop but should only use a "breathable" low VOC water based stain. You can have color added to these products too...like painting, but it's a wood stain that lets the wood breathe. You paid a premium price for your coop in part to pay for the cedar. It will last outdoors in its natural state for many years, better than almost any other wood. Sealing can keep the wood from going grey. That's the main benefit. Clean wood with mild detergent and water or with a commercially available coop cleaner as needed. Glues used in all joints are completely waterproof and all metal parts are galvanized or have exterior rated coatings.

Placement:

Easy access to water/feed and clear access to doors is needed. Sunlight is not all bad, and the Galvalume roof does a good job at not transferring heat and provides shade. Sunlight does a good job at disinfecting the ground under the coop. Fifty percent (50%) or more of direct sun is preferred. Good air movement around your coop is more important than anything else. The proper side should face North if at all possible. Remember... High ground is dry ground **For coop doors to open easily over time, the coop must be level.**

Digging Predators:

The welded wire and cedar frames are stronger than almost any predator less than a bear :) so diggers are the prime nuisance. By far dogs are the most common digger. Other "wild" animals, while more rare, certainly can dig too. If you're worried about diggers, stack heavy block shaped rocks around perimeter of coop to make getting under more difficult. Better yet, bury them around the perimeter just below grade. You can also attach a strip of wire that extends out from the bottom rails, and bury below the surface of the soil. We recommend dirt in bottom of coops that has good drainage. Pine shavings, straw or shredded junk mail can be used in laying areas... but is not recommended in the main run areas.

More About Cedar:

Your coop is built from rough cut domestic cedar. Our 2x2's are actually custom milled. Wood deemed defective is culled during milling, cutting and in fabrication... about 5% 10% does not "make the cut". Knots, blemishes, fraying, coloring variations, minor surface cracking, slight warping and periodic worm marks are normal parts of natural wood products. We try to make it to where a reversible part always has a "pretty side" and take care to make the "pretty side" show on all parts. If you're unhappy with a piece of wood we fabricated into your coop, send us a picture. We want you to love every piece of your new coop.



Please Be Careful



Coop is designed to be assembled by two people of ordinary skill.



Some of the steps will need to be performed from a six foot or taller step ladder. If you are not comfortable and experienced standing on and working from a ladder you may want to get some help for those steps. Please be careful.

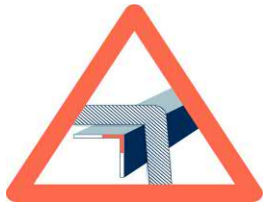

Any roof metal and flashing can have sharp edges. We attempt to knock off sharp corners and edges from roof metal. You must be the final determiner of sharp edges. A standard metal file from your hardware store, or metal snips, can be used to make edges to your standards. You may choose to wear a pair of work gloves while handling roof metal.



Spending the time up front to identify all the parts and lay them all out will pay off in the long run and make assembly go more smoothly. The instructions are intended to be read in page order as, the information builds in that way, then referenced during assembly. Pre-reading the instructions will help immensely.



Be careful not to get caught in coop. Children should not play in coop as the doors are not designed to allow easy exit.



1. Color of screws may vary due to post COVID era supply quirks.
2. We provide extra screws. You will have leftovers.

Tools & Loose Parts

QTY Description

- 10 Gold T-25 4 1/2" Screws
- 250 Brown T-25 3" Screws
- 75 Green T-20 1 5/8" Screws
- 1 Bolt Style Gate Latch
- 2 Eye Bolt & Hooks
- 100 Neoprene Washer Roof Screws
- 1 Bit Holder
- 1 T-25 Bit
- 1 T-20 Bit
- 1 #2 Phillips Bit
- 2 12" Stake Nails
- 1 2' Level
- 1 Countersink Bit
- 1 1/8" Jobber Drill Bit
- 1 10 Feet of String
- 12 5/8 Phillips Screws for Ramps
- 12 1 1/4 Flat Head Phillips Screws For Door
- 2 Snap Clips
- 2 Stock Storm Panels for Roost Doors
- 1 Gravity Gate Latch
- 6 1 1/4 T-20 Yellow Screws

Optionally, your kit may have the following items and loose parts...

- 2 4" Pipe Waterer Sections
 - 1 Slotted Waterer Cap
 - 4 Poultry Nipples
 - 1 Small can PVC Glue
 - 4 Feeder Tubes & Caps
- Extra Hardware Related to Sun-Room Option

Front Wall

A4 Front Arc

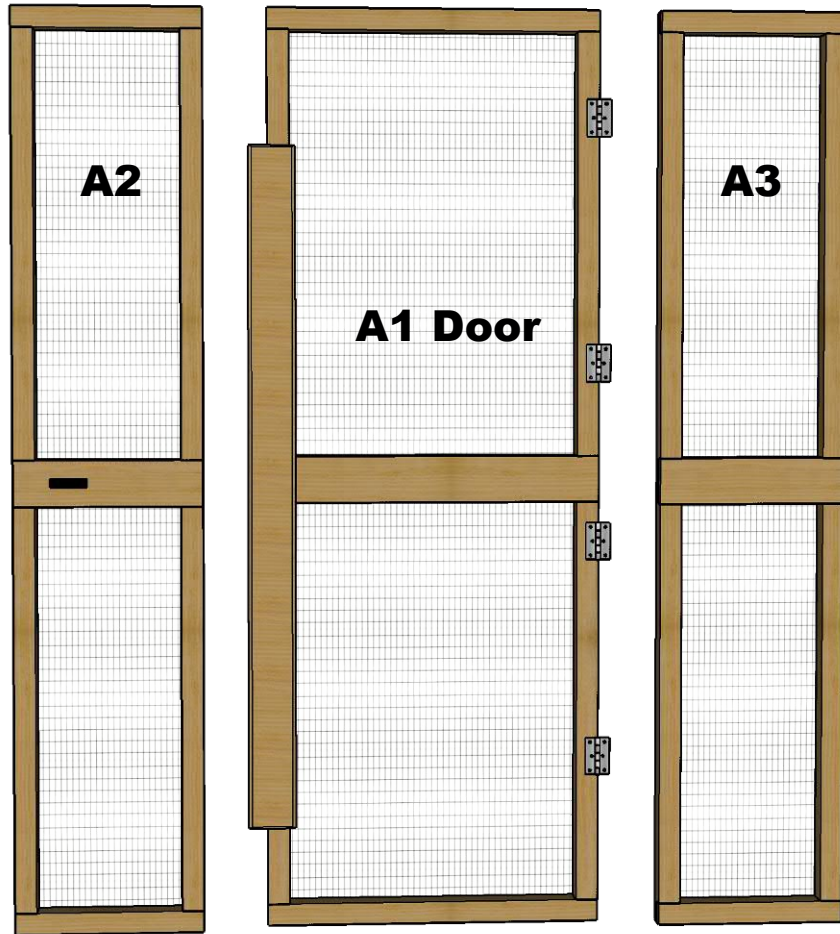
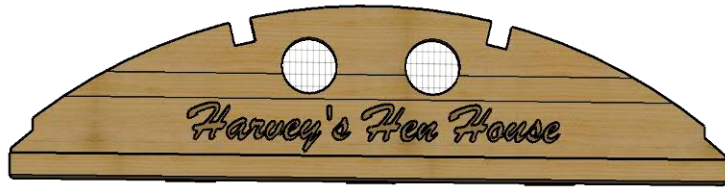

Back Wall

D2 Back Arc

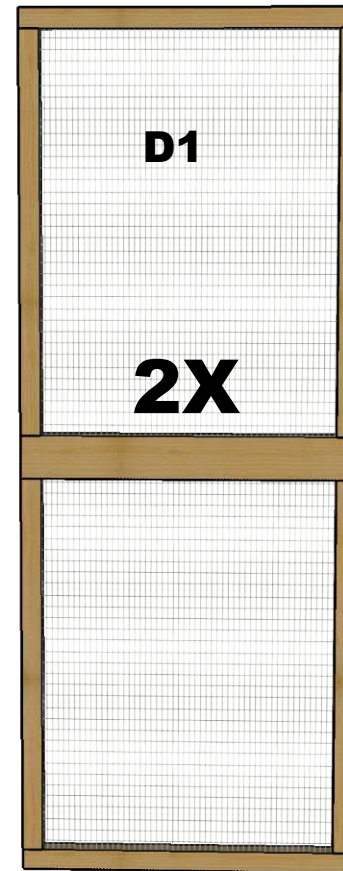
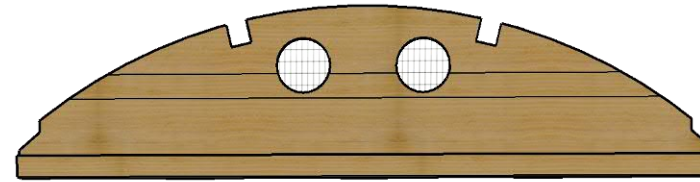

Step #1 is a little time to identify parts...



Find shipping screw in door frames that keep doors closed during transport and remove them.

Beveled Top Edge

Wire stapled to Interior side of panel

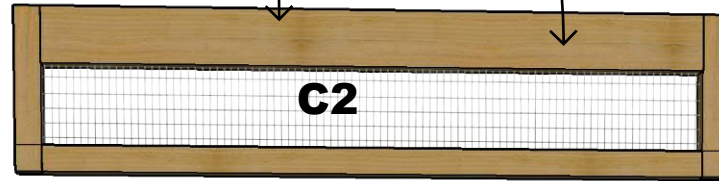

2X

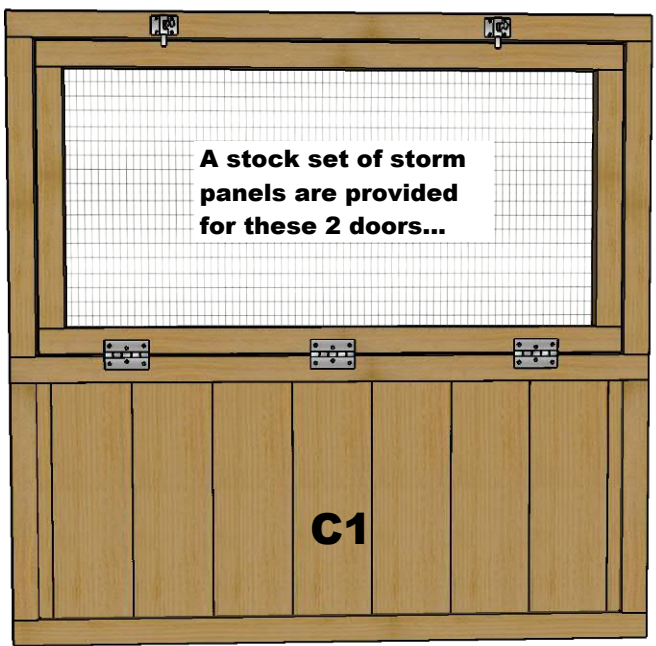

Looking From Inside Coop

... here we go!

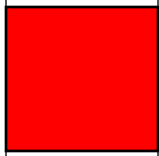

Back of Coop

Front of Coop

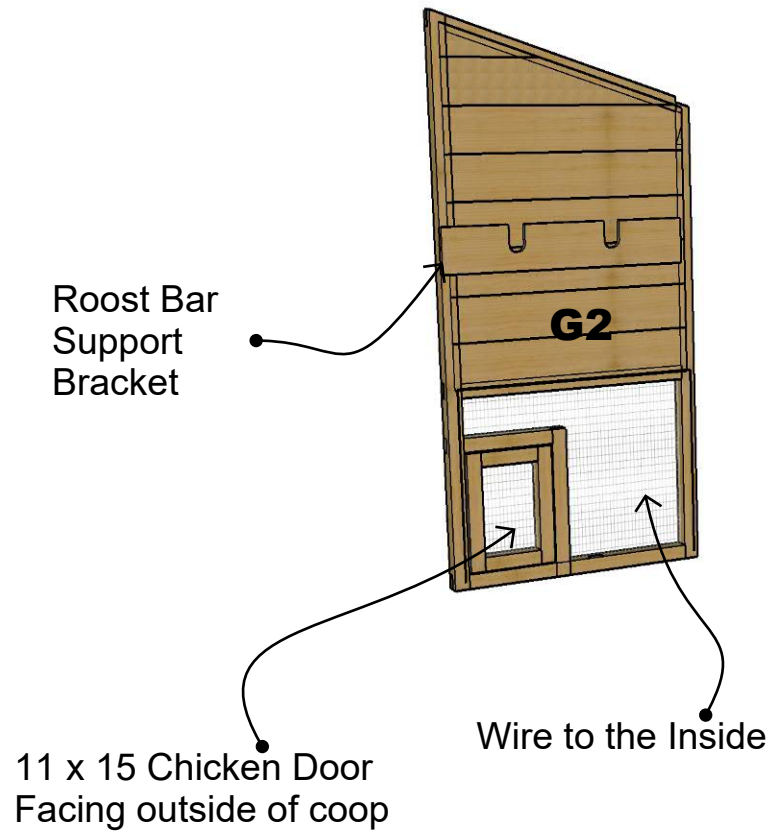

Door opening fits a "Standard" sized automatic turnout door from www.chickendoors.com

Beveled
Top
Edge



2X

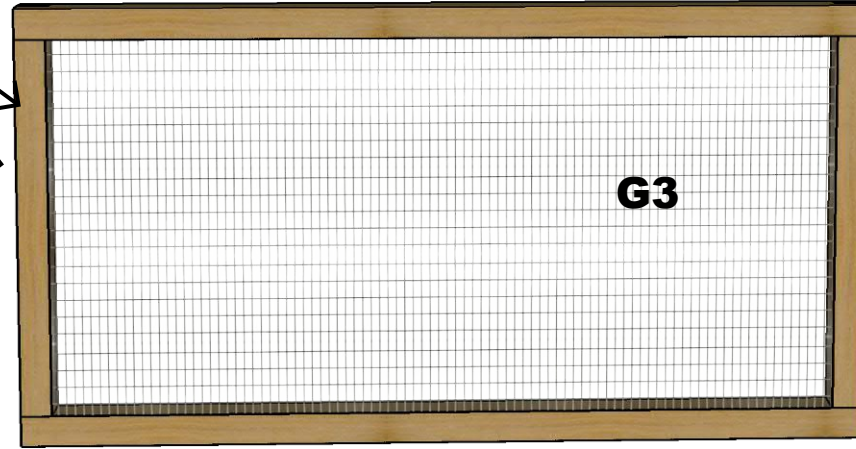

Wire On
Backside

**Looking From Outside
Coop**

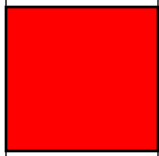
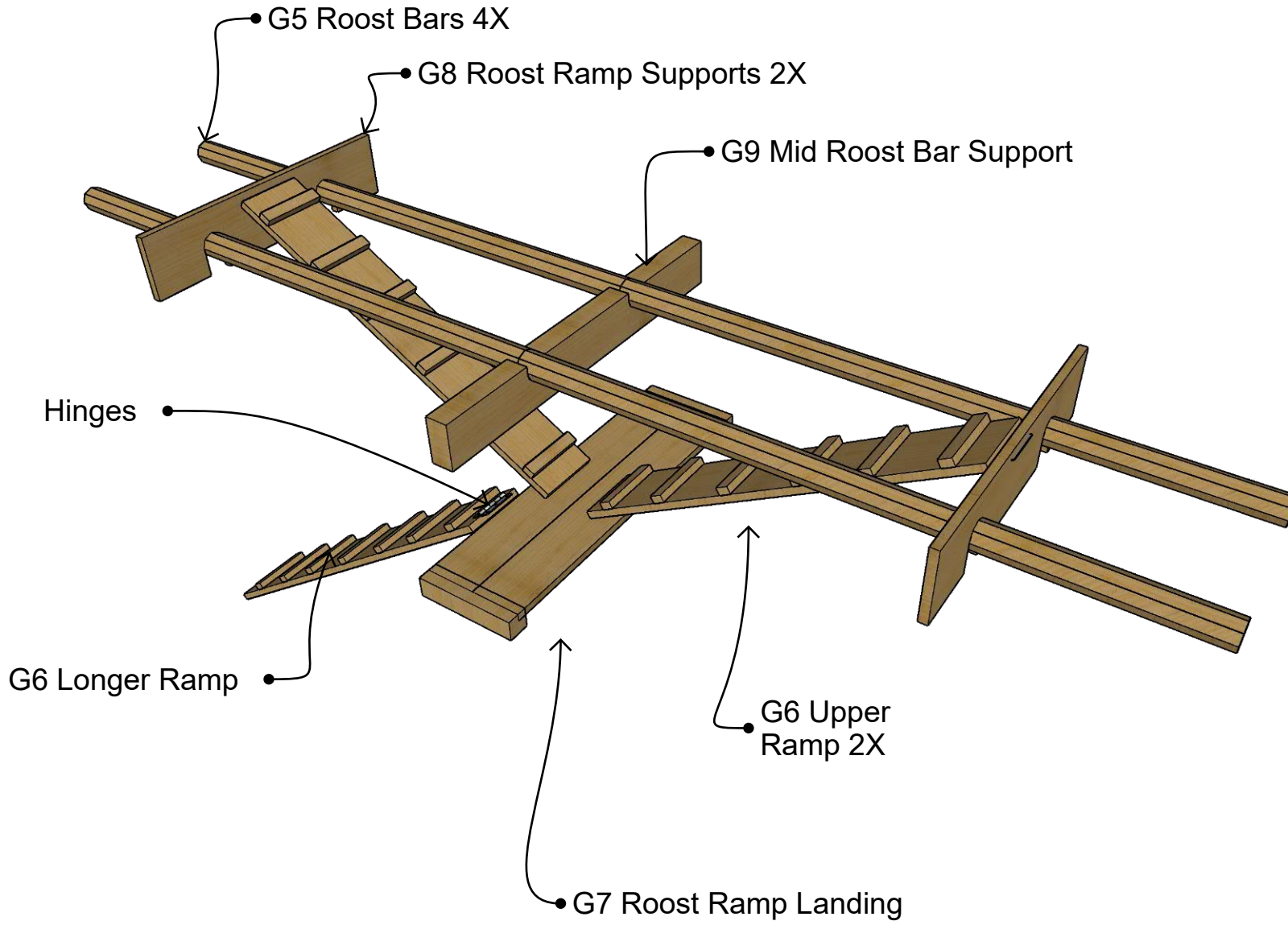

G13 With Trimmed Edge is for the lower Roost section

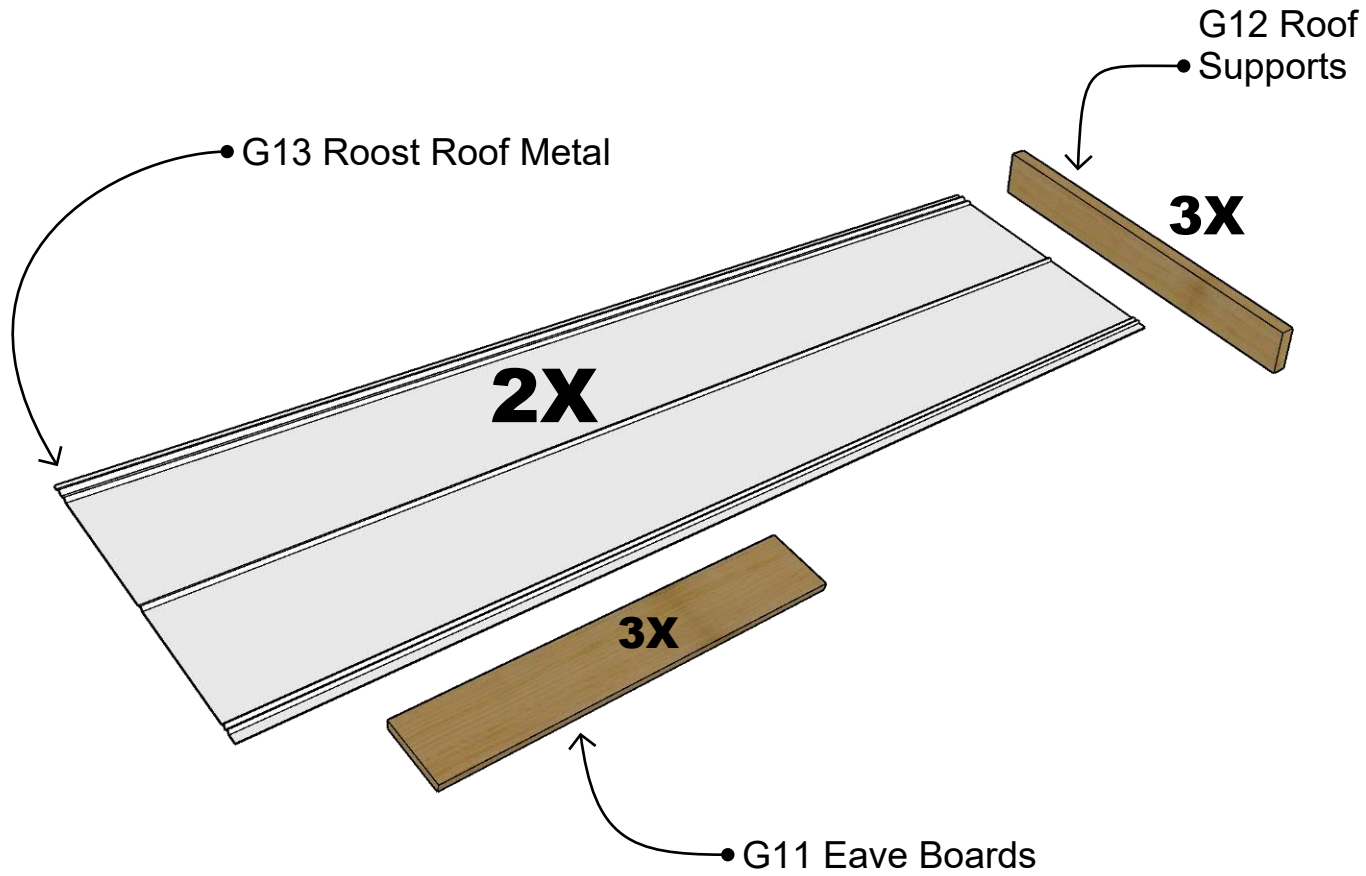

Looking From Inside Coop

Beveled
Top Edge

Wire
Side

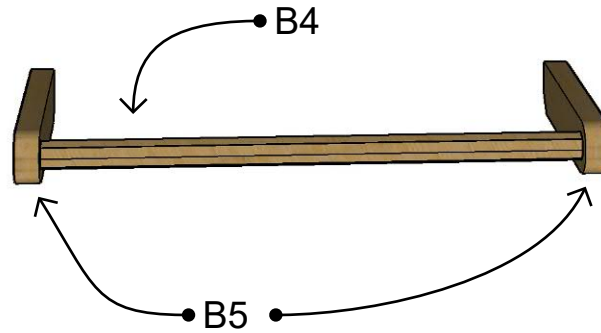
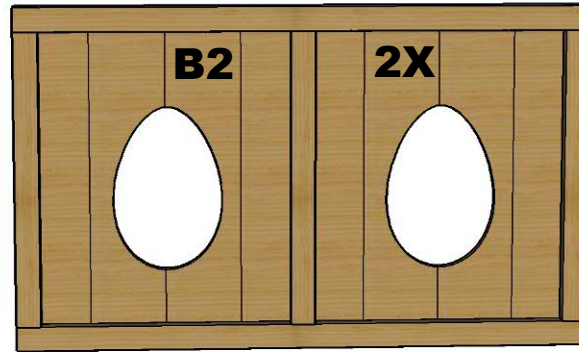
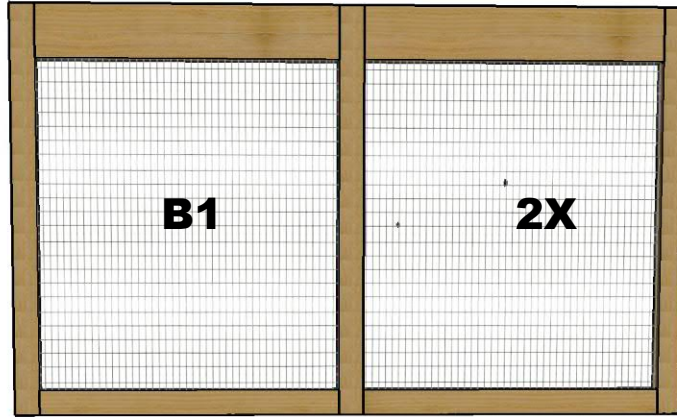

Two Sets of this
Perch Assembly

**Back of
Coop**

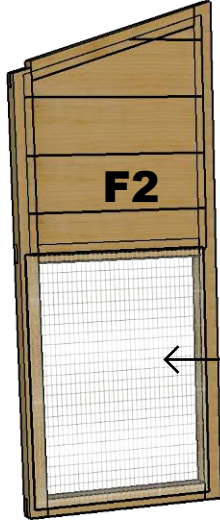

Wire
Side
In



**Front of
Coop**

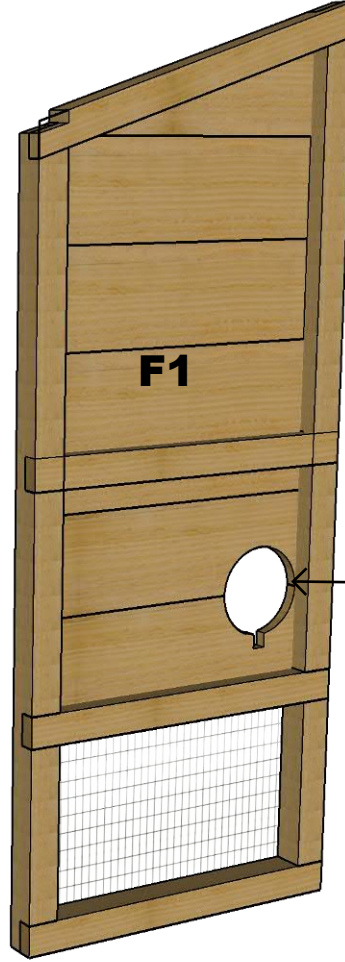

Hole For
Optional
Waterer



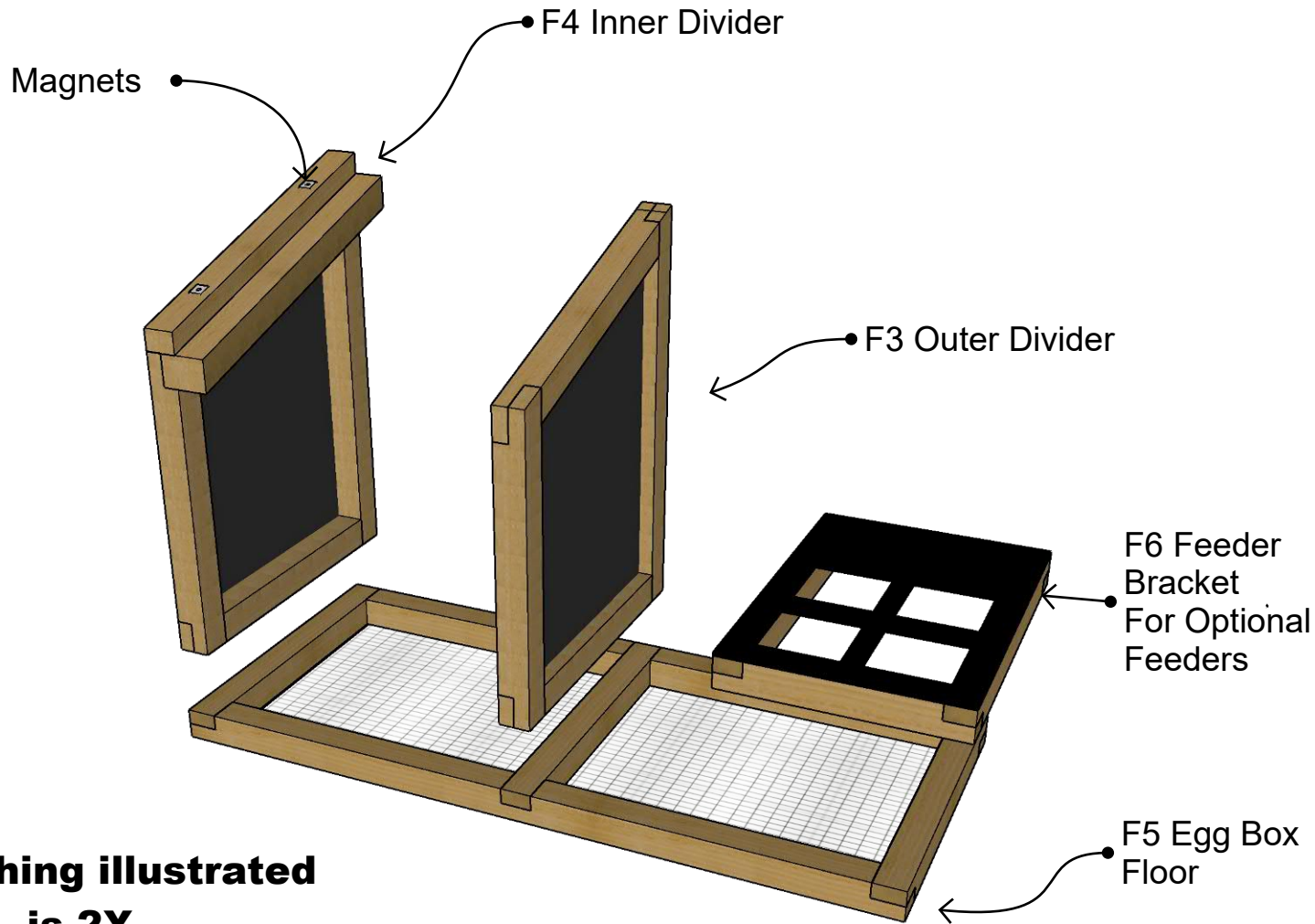

**Everything illustrated
is 2X**

Beveled Top Edges

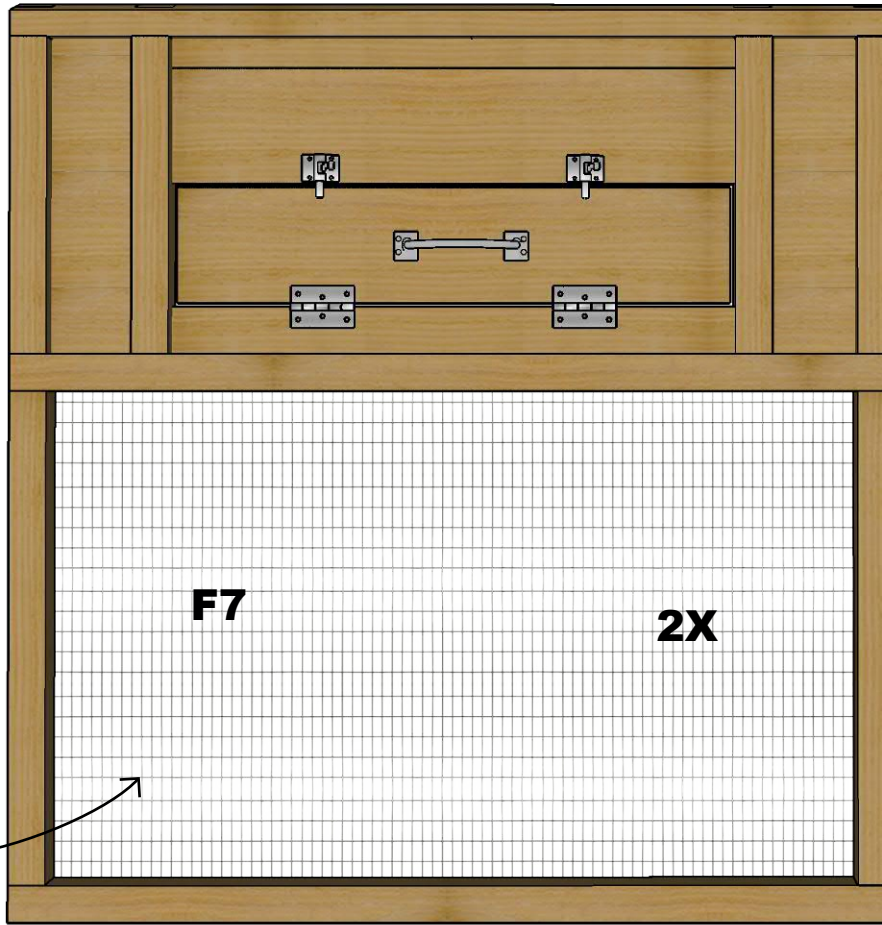
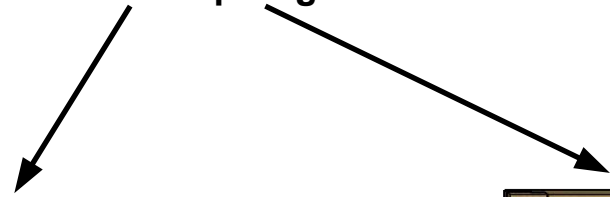

Wire to Back



Looking From Outside
Coop

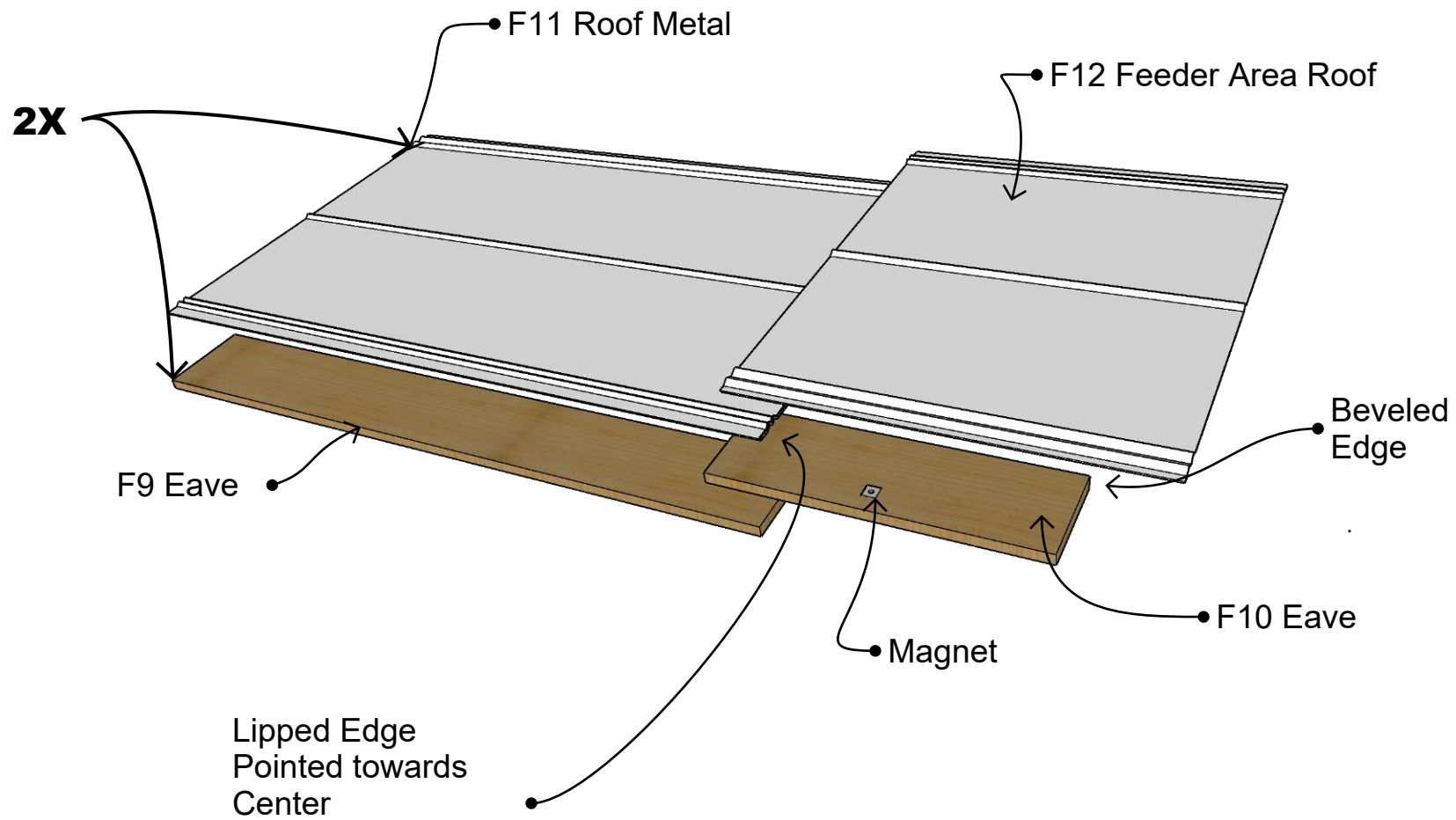

2X E2 Roof Supports

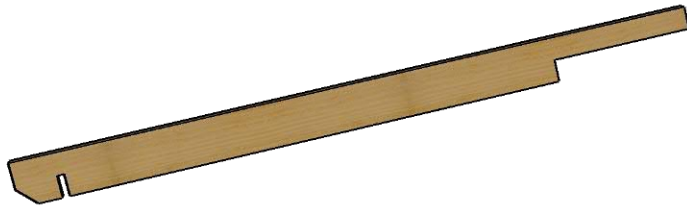

E1 Mid-Arc

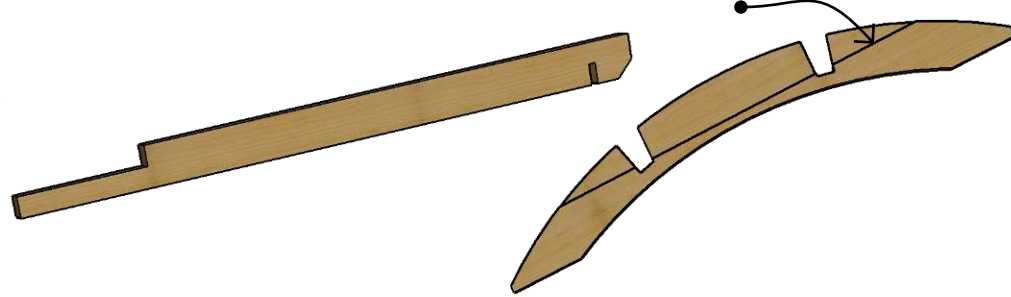

E4 Galvalume® Roof Metal Panels

6 equal length roof metal sections.

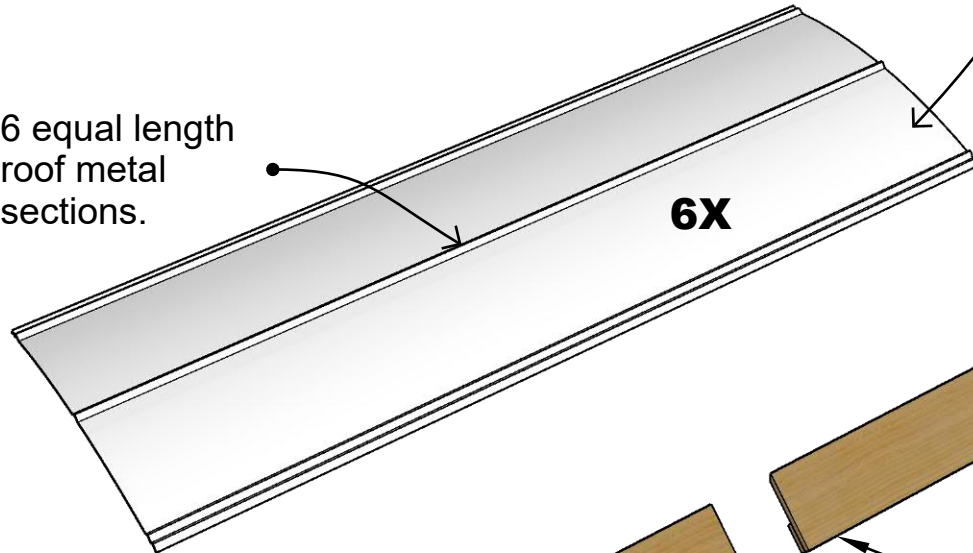

6X

6 piece set noted by red, green and yellow stickers.



Beveled Top Edges

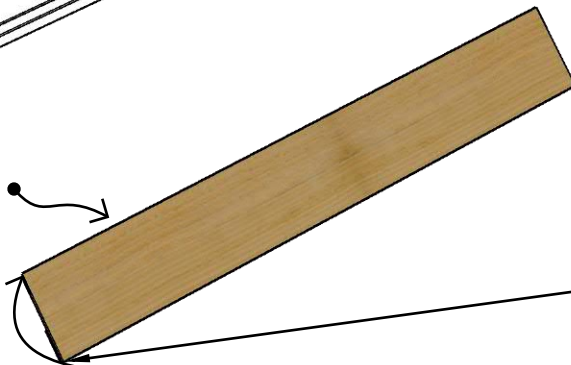

Magnet

6X

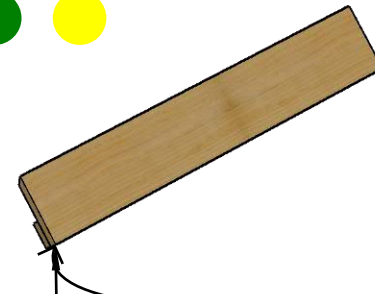

Magnet

E3 Eaves

2 Sets of 3

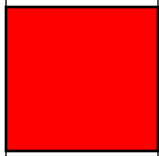

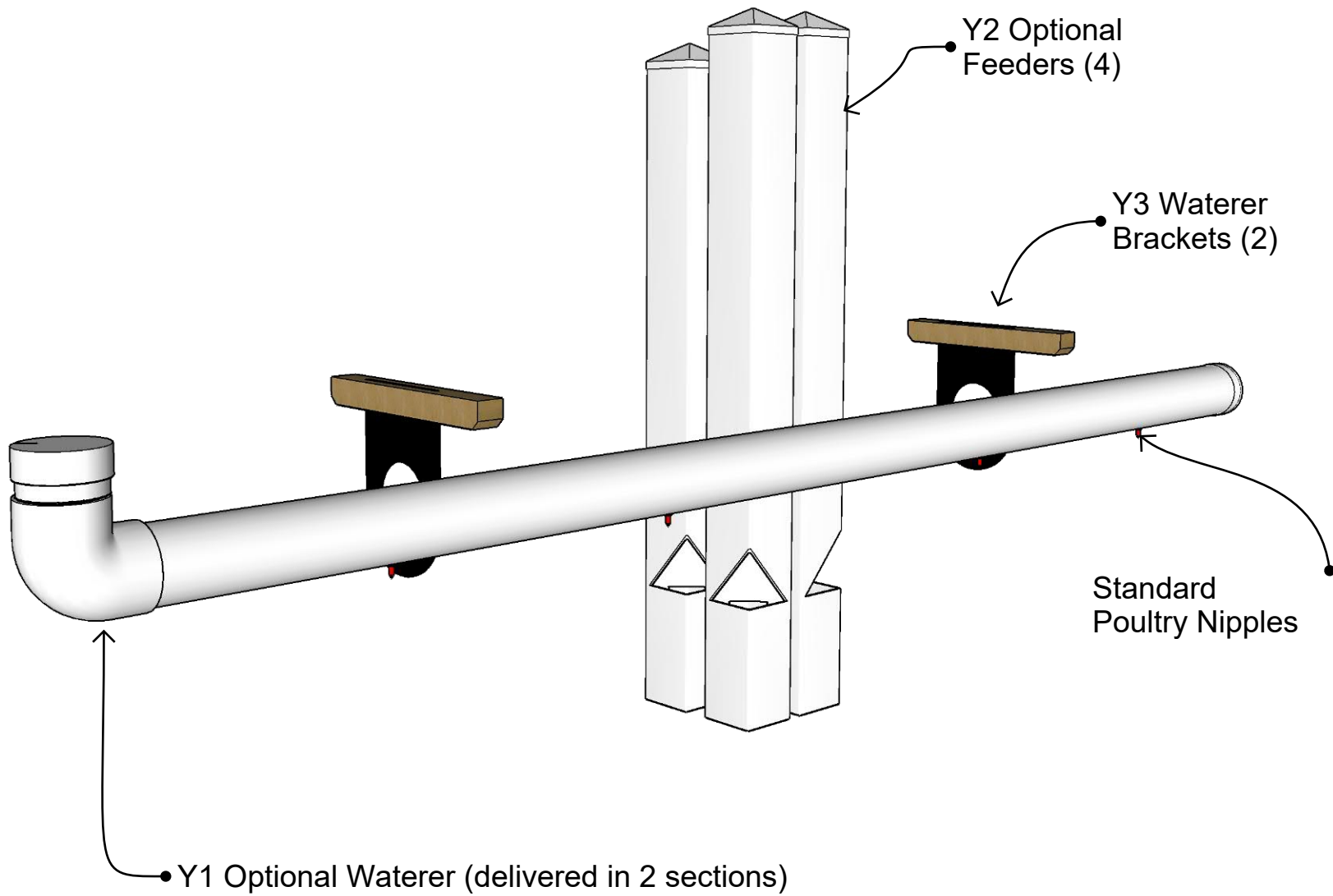

This is what you're about to build.

Section 1 - Run Area

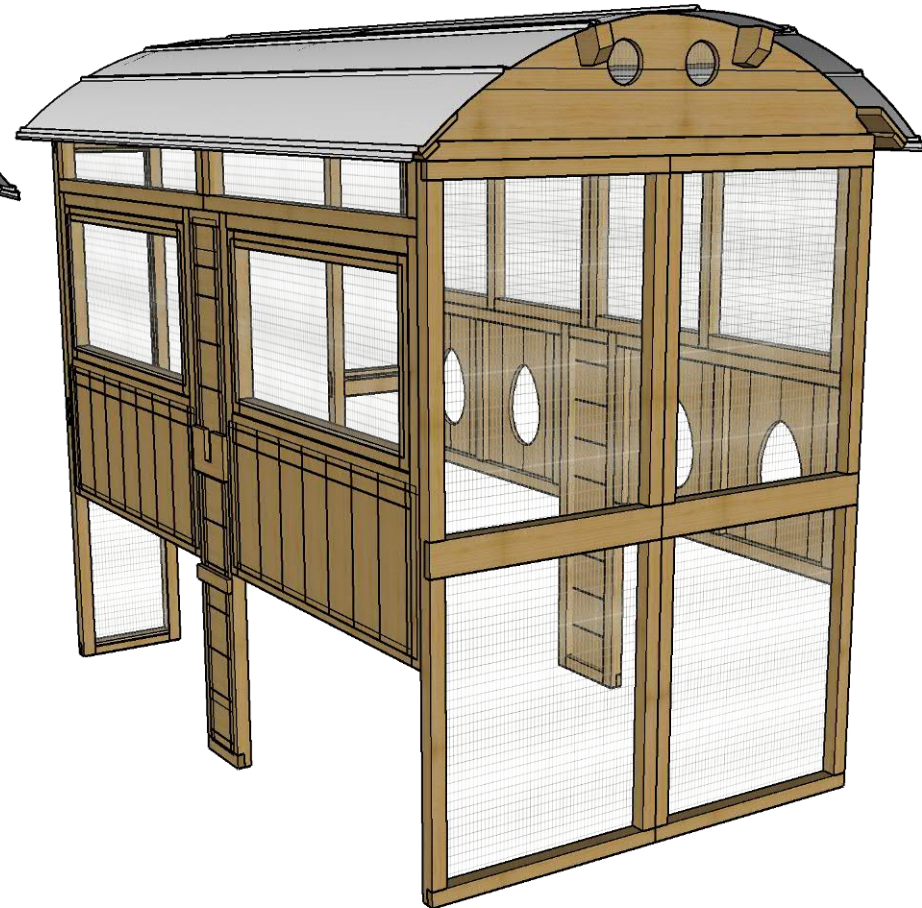

Start With The End in Mind...

The start of each section has an illustration of what you'll end up with, after that section is complete.

Build on level ground.

Finished coop will weigh 800+ pounds and is not designed to be moved without at least partial disassembly.

• Not our quote ;-) but we like it!

Your Drill



Bit Holder
+ Included



T25 Bit
+ Included



T25 3 Inch Screw
+ Included



Your Measure Tape

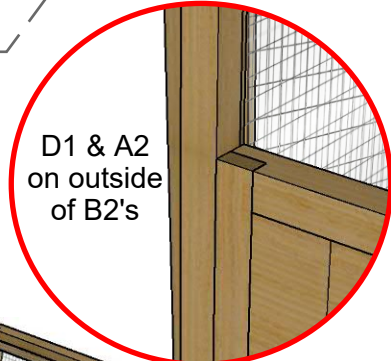

Flush Tops

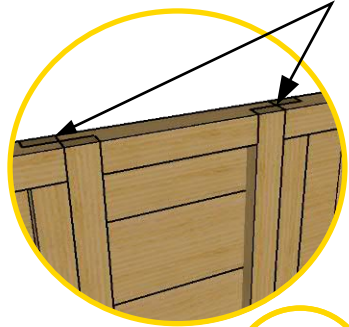

Gold arrows indicate a T25 3" Screw and its direction.

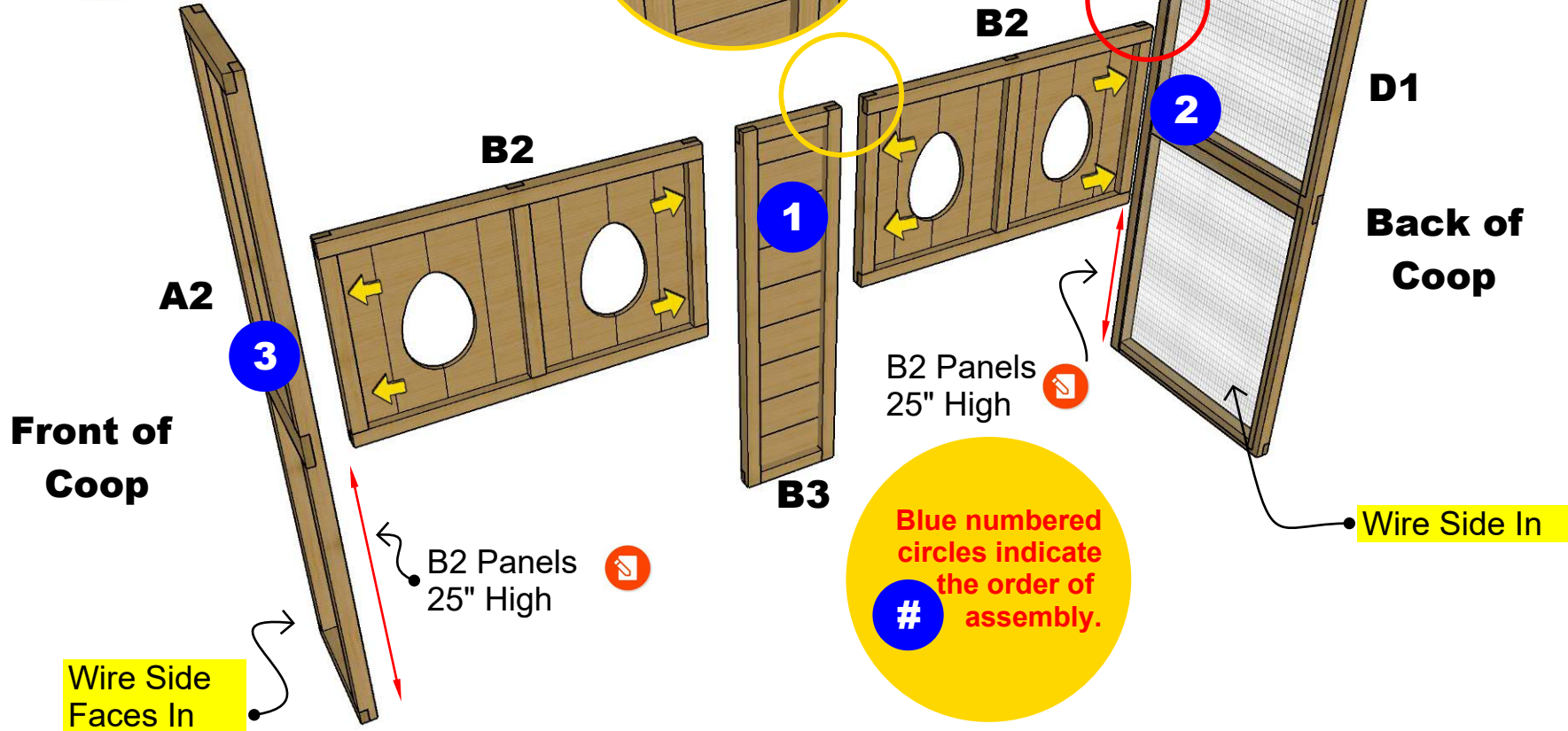

MADE IN USA
roost&root
Find your inner farmer.™

Assembly Instructions
Round-Top Walk-In Coop
Model 2 V1 2022
Copyright © Roost & Root all rights reserved.

Step 1A - Lower Left
Run - Egg Box Inner
Wall

Back of Coop

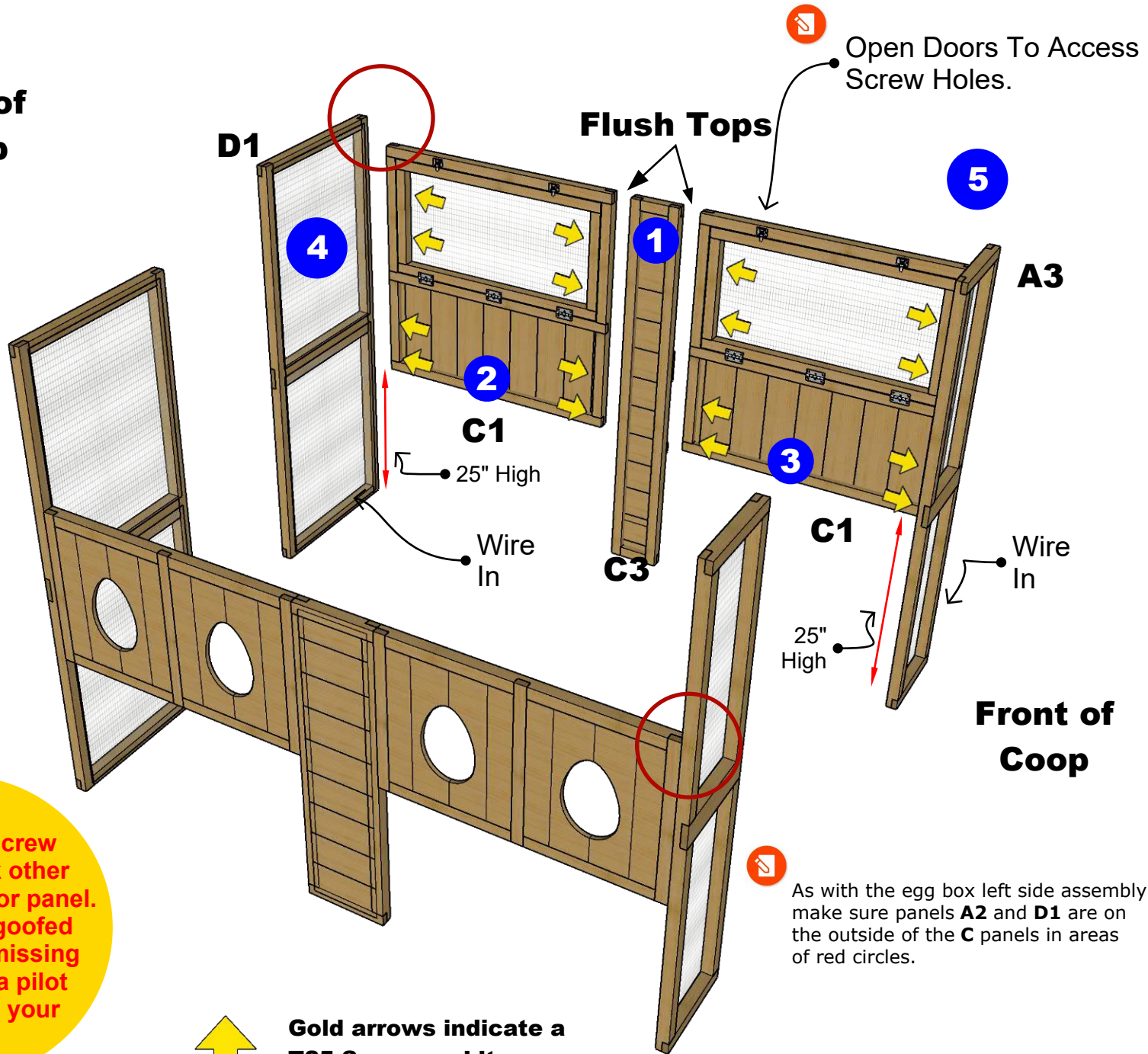

Open Doors To Access Screw Holes.

Flush Tops

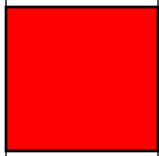

If you don't see screw holes check other side of board or panel. If our shop goofed and they're missing we include a pilot bit to make your own.



Gold arrows indicate a T25 Screw and its direction.



**Back of
Coop**

Flush Tops

**Gold arrows indicate a
T25 Screw and its
direction.**



Okay, got it.

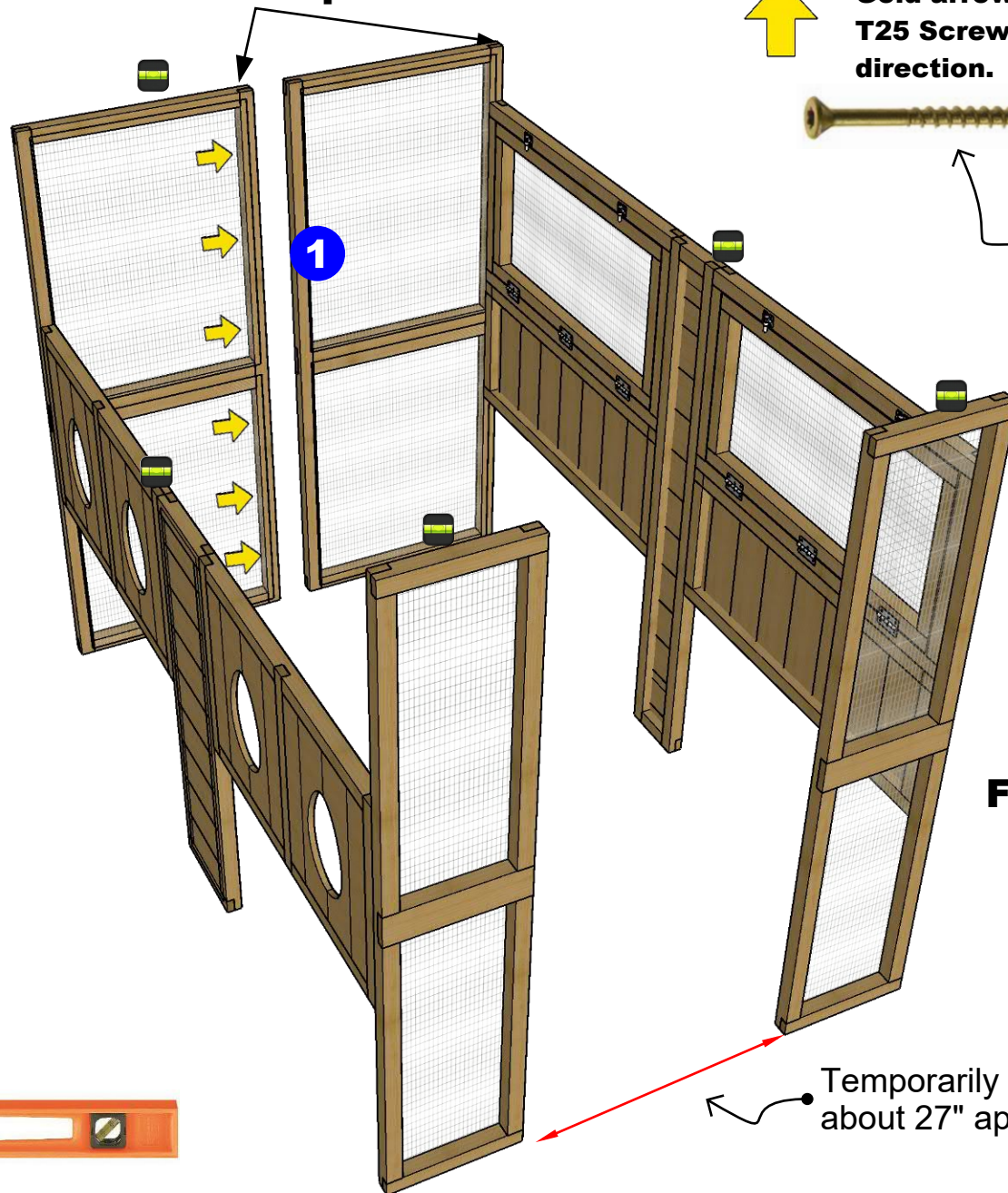

**Front of
Coop**



**Using provided level
check what you have built
so far on all sides and adjust
soil and contact points as needed.**

3

Temporarily place to
about 27" apart... **2**

 **Wire Facing**
In on B1's

 **Bevel Slant Down & Out**
Flush Tops

**Front of
Coop**

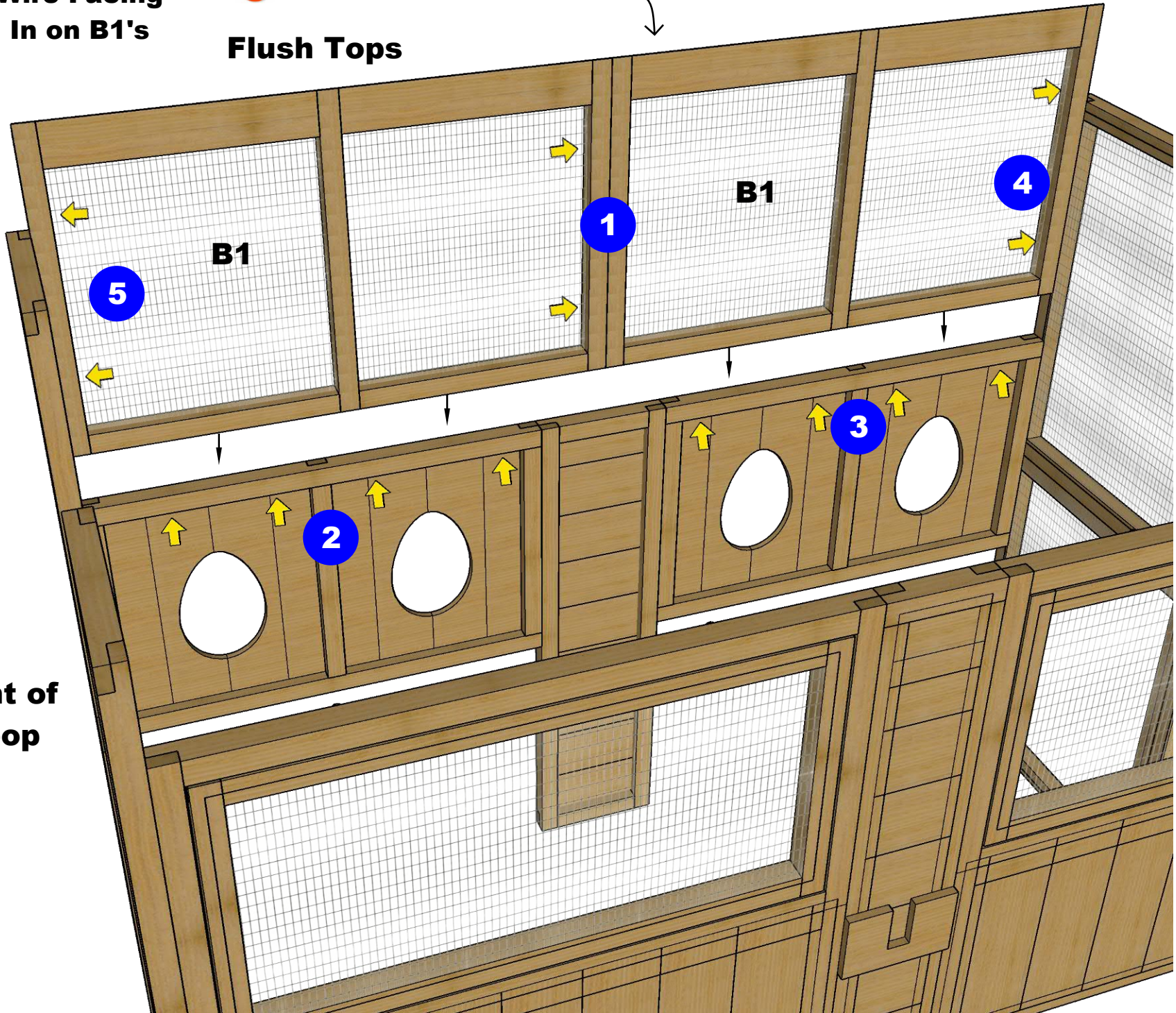

MADE IN 
roost&root
Find your inner farmer.™

Assembly Instructions
Round-Top Walk-In Coop
Model 2 V1 2022

Copyright © Roost & Root all rights reserved.

**Step 1D - Upper Egg
Box Panels**

Open C1 Doors to Access Screws

Front of Coop

Wire Side Faces In
Bevel Top Slopes Down & Out

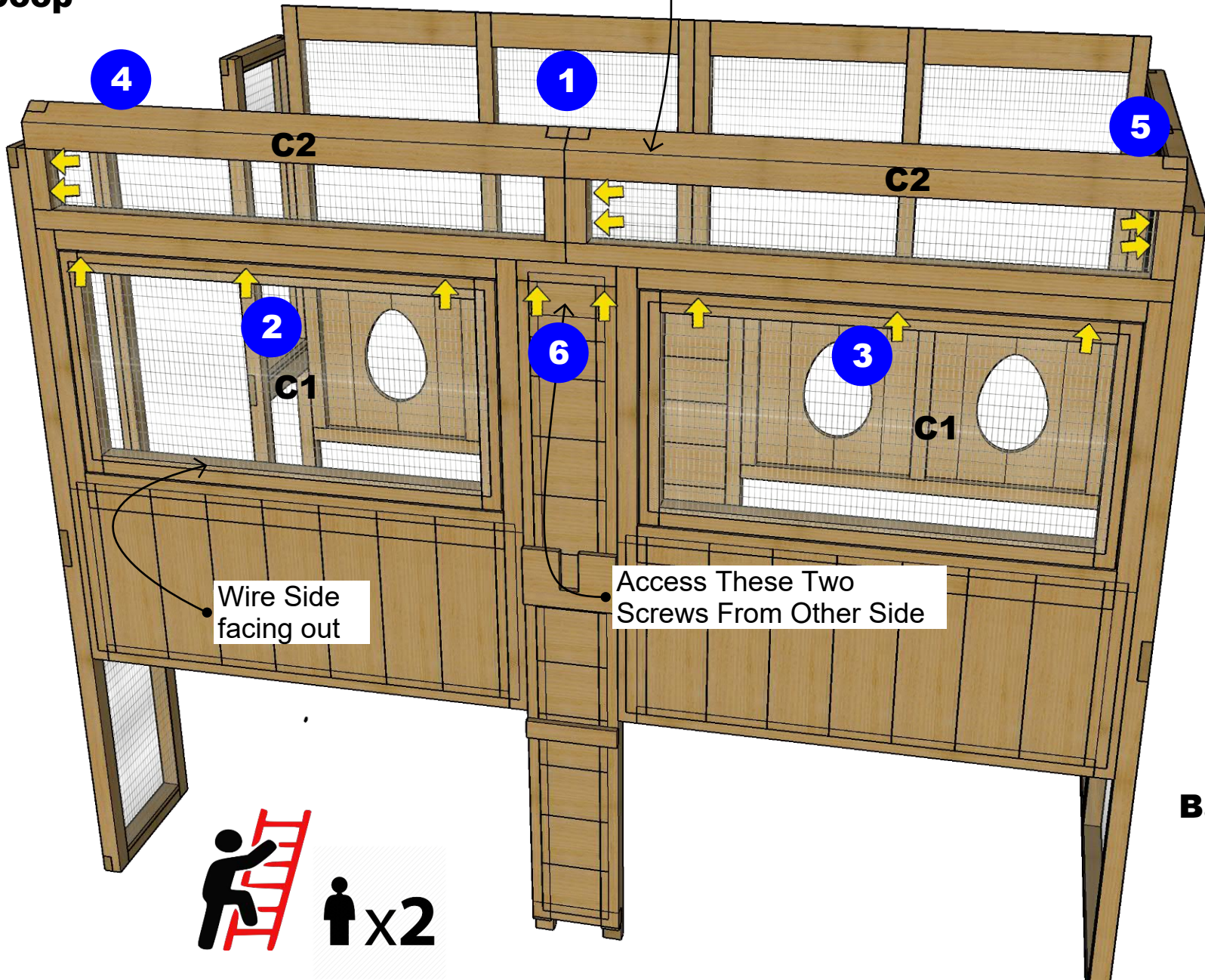

Wire Side facing out

Access These Two Screws From Other Side



Back of Coop

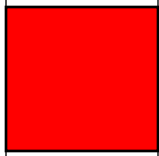



Assemble E2's as straight as possible. One trick would be to use the provided string stretched along its length after first screw and make it straight before screwing all 4 screws in...

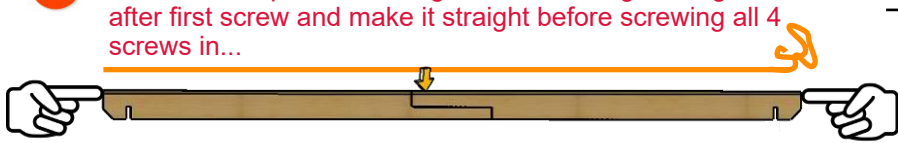

3

After connecting E2 halves slide down into place locking notches into A3 & D2 arcs. E1 mid roof stabilizer slides up from under E2's to lock in place. Fit best way... its reversible.

Assemble Very Straight

4X E2's

1

4

2

E2 roof support notches lock into A3 and D2 notches.



Front

Back

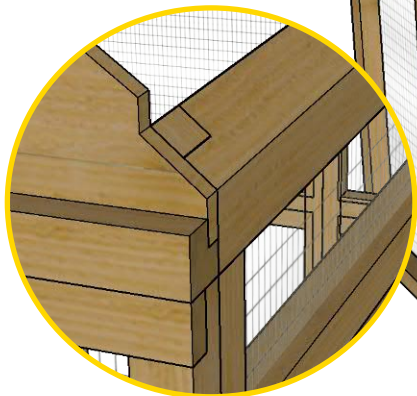

Flush Edges



Use 2 of the Long T25 Gold Screws



i x2





4 Door Side Stakes

When everything is great... hammer door stakes into pre-drilled holes to pin door width into place.



Use your hammer.



Use your measuring tape in step 1 & 2

4 Adjust Door Width

27 1/2 Inches

3 Using provided level double check top edges both sides... Should be pretty spot on.

2 Using provided string, stretch along bottom and tops on both left and right sides and make sure middle sections aren't bowed in or out.

Push/pull in or out as needed to make sides straight along string and not change corner to corner measurement established in step 1.

2

1

2

1

Measure inside corner to corner and adjust coop until equal... this is called "squaring" and is critical for remainder of steps. Pick exact points to measure from. Make as equal as possible.

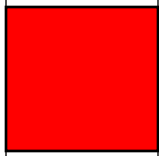
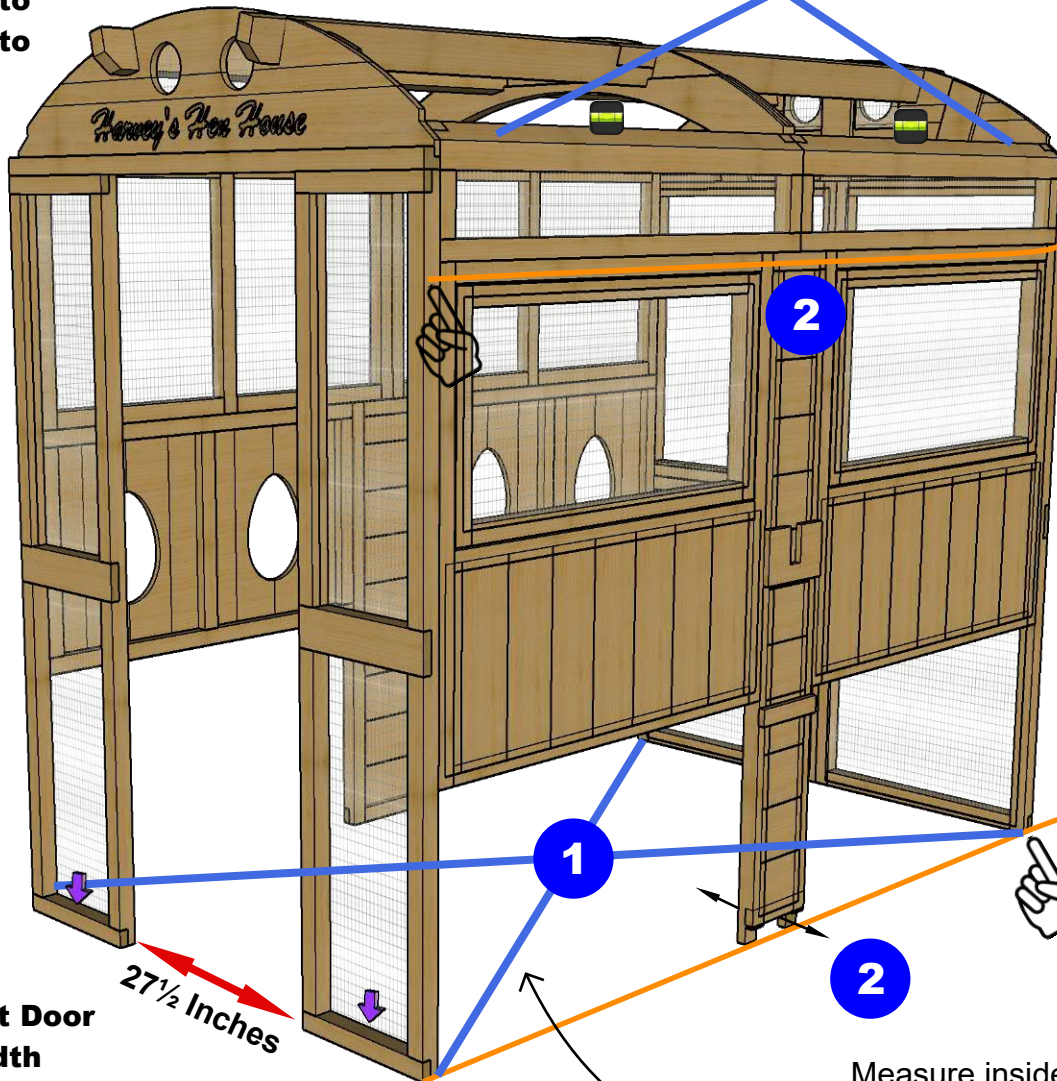

Move, level and adjust as needed. After this step coop will become too heavy to move.

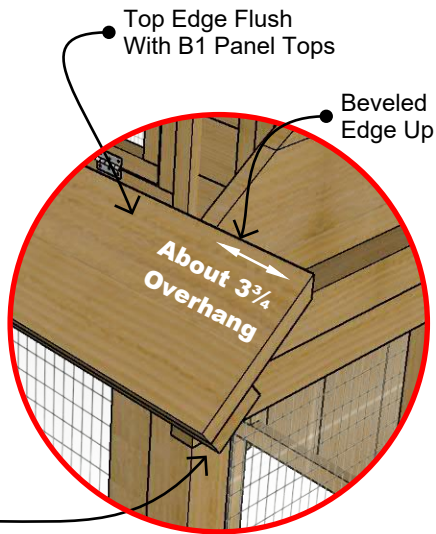

Double Bottom Boards

Middle eave board centered.
Repeat pattern both sides.

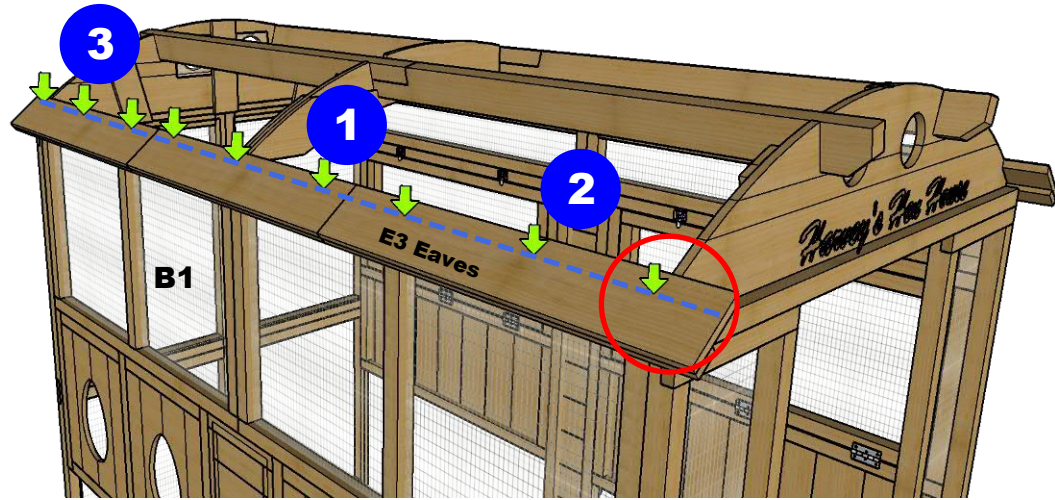

Identify the 6 run roof panels and their features...

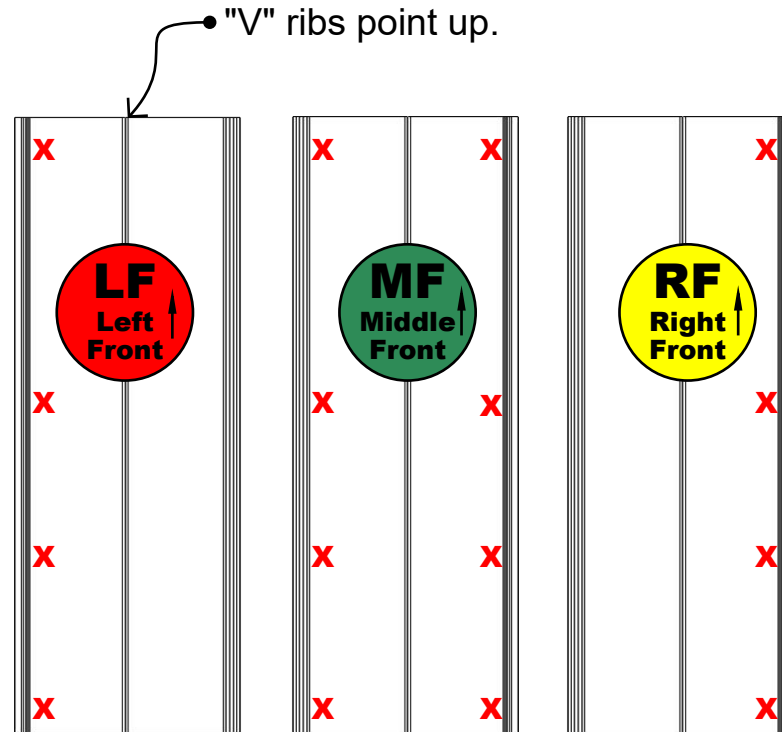
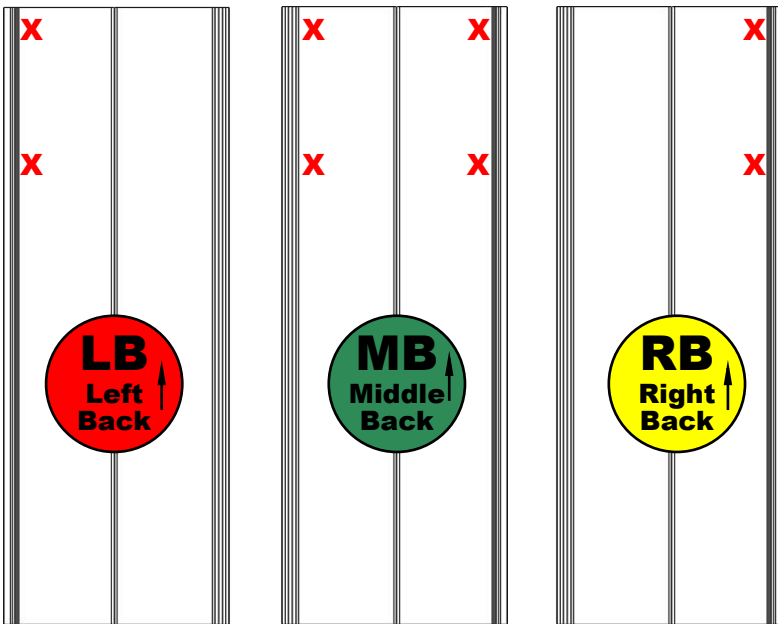

The 6 run roof panels are labeled with colored stickers as indicated. X indicates hole pattern. These 6 panels are the slightly shorter ones...

↑ Arrows point to back of coop...



Using provided bit holder and neoprene washed roof screws you will install the 2 piece center portion of the roof as illustrated.

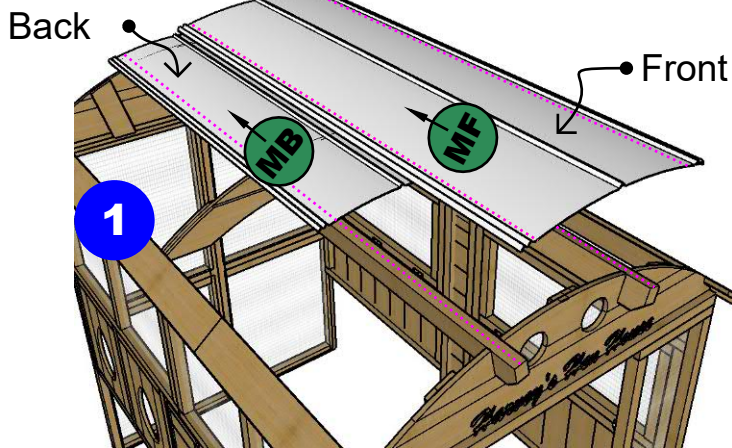

**Screws for center roof panels
sink into mid-roof supports**

1 Overlap center front roof section on top of center back roof section (front on top of back) using V ribs to align pieces and sliding them into place until a little over an inch of roof overhangs the E2 center roof support ends. Make sure they're laying straight and flat. Arrows on green MB and MF stickers point towards back of coop.

2 Being careful not to shift pieces, install a roof screw in positions as indicated by blue arrows to hold two panels in place. Try not to shift anything by leaning against it. Leave screws very loose.

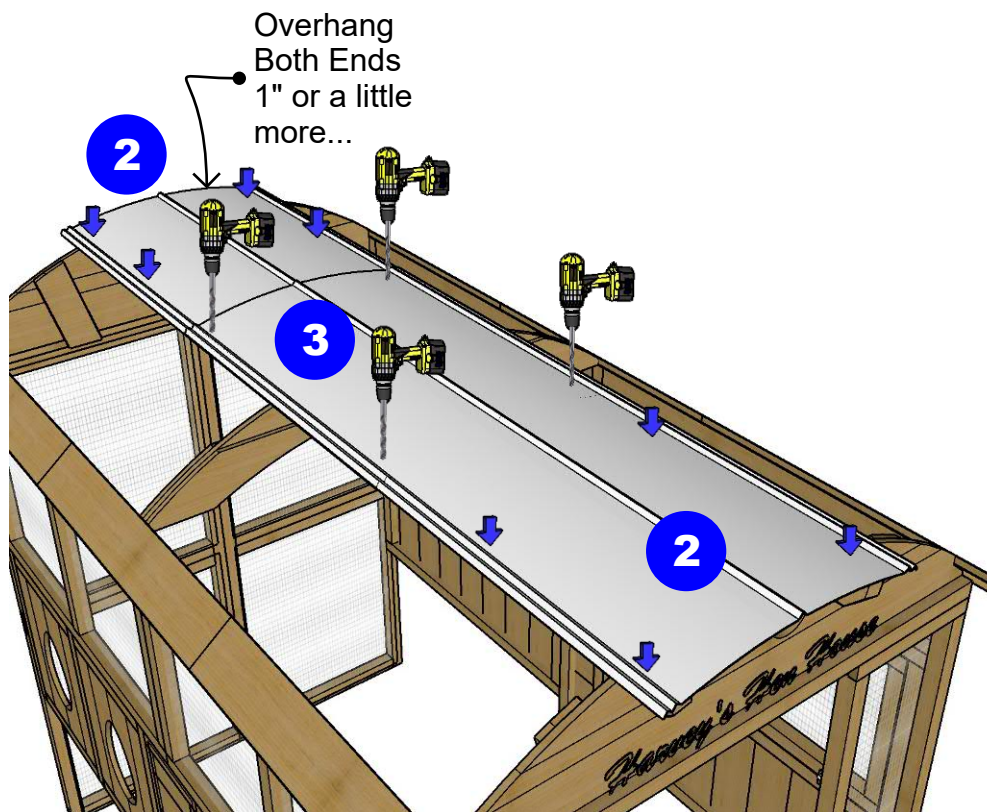

Please Be Careful



3 Again, being careful not to shift pieces, use your drill and provided small drill bit to drill through the MB bottom back piece of metal using pre-drilled holes in top piece of MF metal for guides. Try your best to not drill into the E2 supports. Only the bottom layer of metal. If you're strong, the screws can pierce the bottom without pre-drilling. Install roof screws in these 4 holes through both layers into E2's leaving very loose.



**Leave all screws loose at this point...
Once all panels are slipped in, you'll tighten everything.**

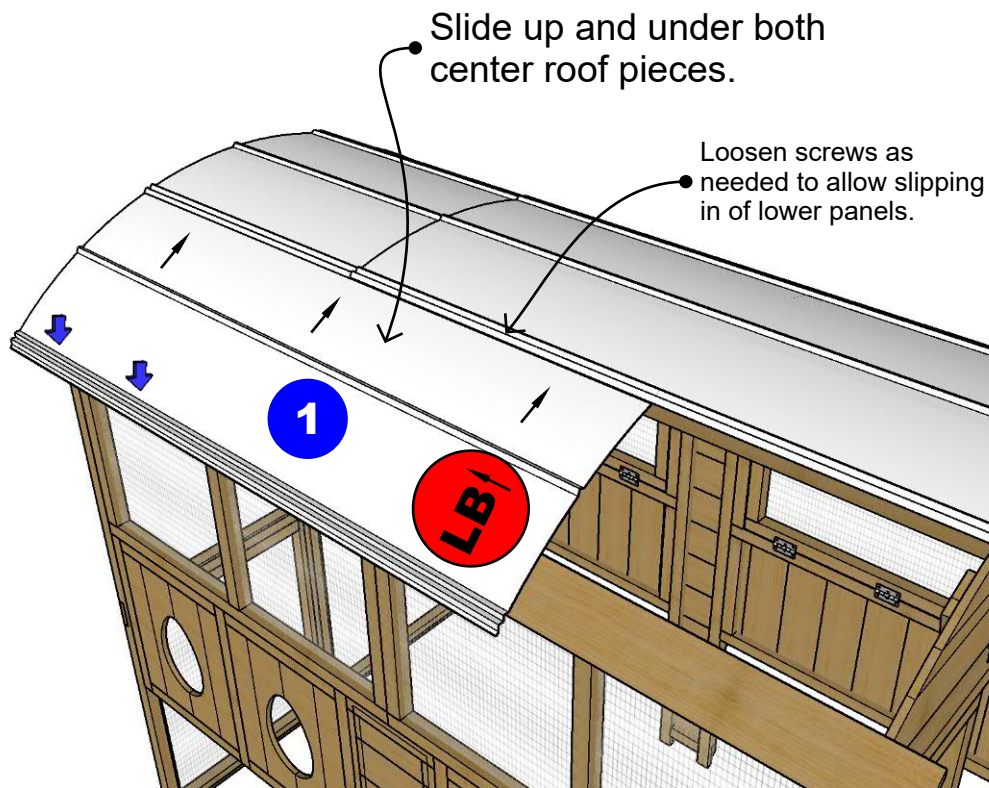

Please Be Careful

1 Slide LB left back roof panel up and under both layers of center roof sections until V grooves of center roof section line up on top of V grooves in LB panel. After making sure entire length of roof section is aligned nicely, install two lower bottom edge roof screws into eave edge. Tighten only enough to compress neoprene rubber washer... try not to over tighten.

2 Slide LF left back roof panel up and under front layer of center roof section until V grooves of center roof section line up on top of V grooves in LF panel. After making sure entire length of roof section is aligned nicely, install two lower bottom edge roof screws into front eave edge. Tighten only enough to compress neoprene rubber washer... try not to over tighten. Drill remaining two holes using same considerations as in previous step and install and tighten screws.

Be careful not to lean on or shift structure too much. As screws get tightened and the full structure gets assembled things will stiffen up and become solid.

3 Tighten screws along the left side center panels to where the neoprene rubber washer is compressed and pin the panels that you slid under down into place.

4

RB
Right Back

RF
Right Front

Repeat this entire procedure for the right side run panels first installing RB back panel then the RF front panel using the same procedure as you just did for the left panels.

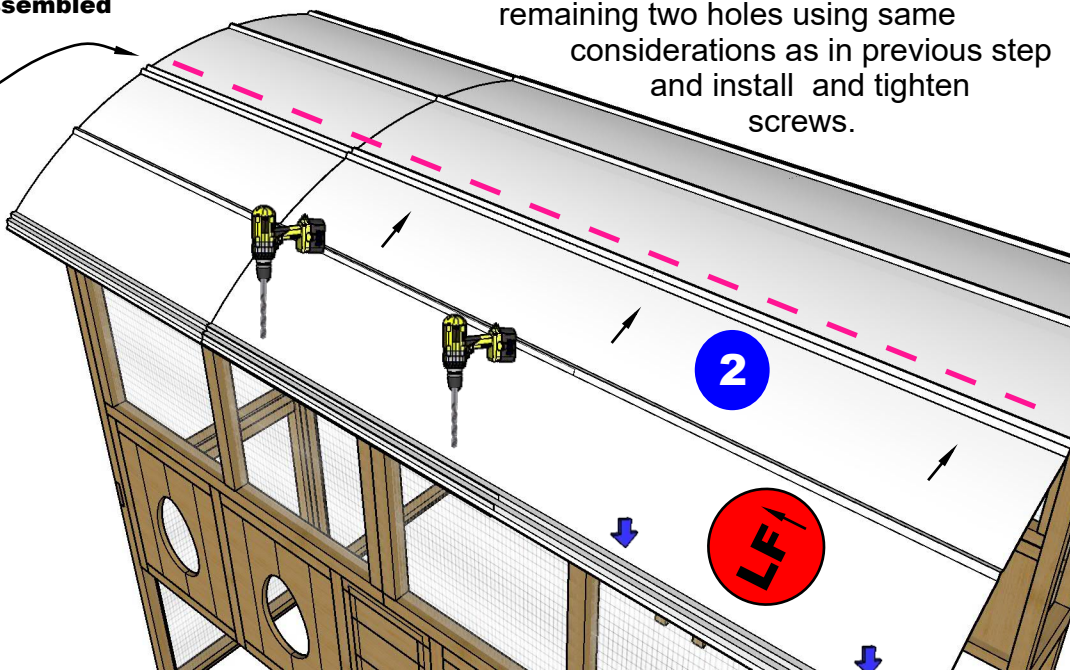



Instructions going forward will omit some complexity as HOPEFULLY we did a good job laying some common foundations and you are catching on to the techniques and our lingo. You can always call our support hotline at 877-741-2667 or text your questions and photos to 512-596-5200.

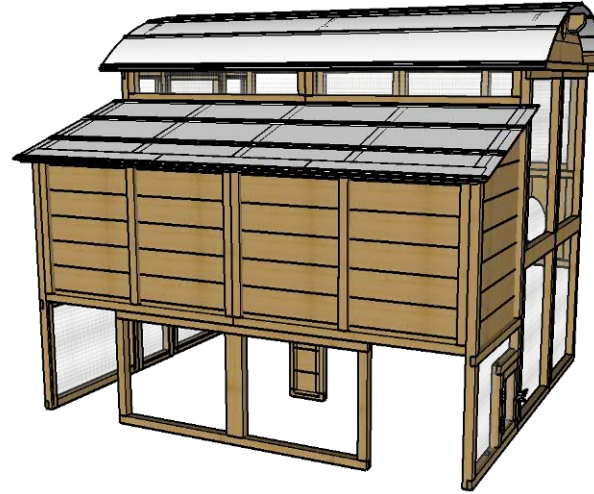

Optional Sun Room support panel shown holding up outer roost wall. Your coop will look like this after this step is complete if you ordered an XL model with a Sunroom.

XL Sunroom is completed after main coop assembly.

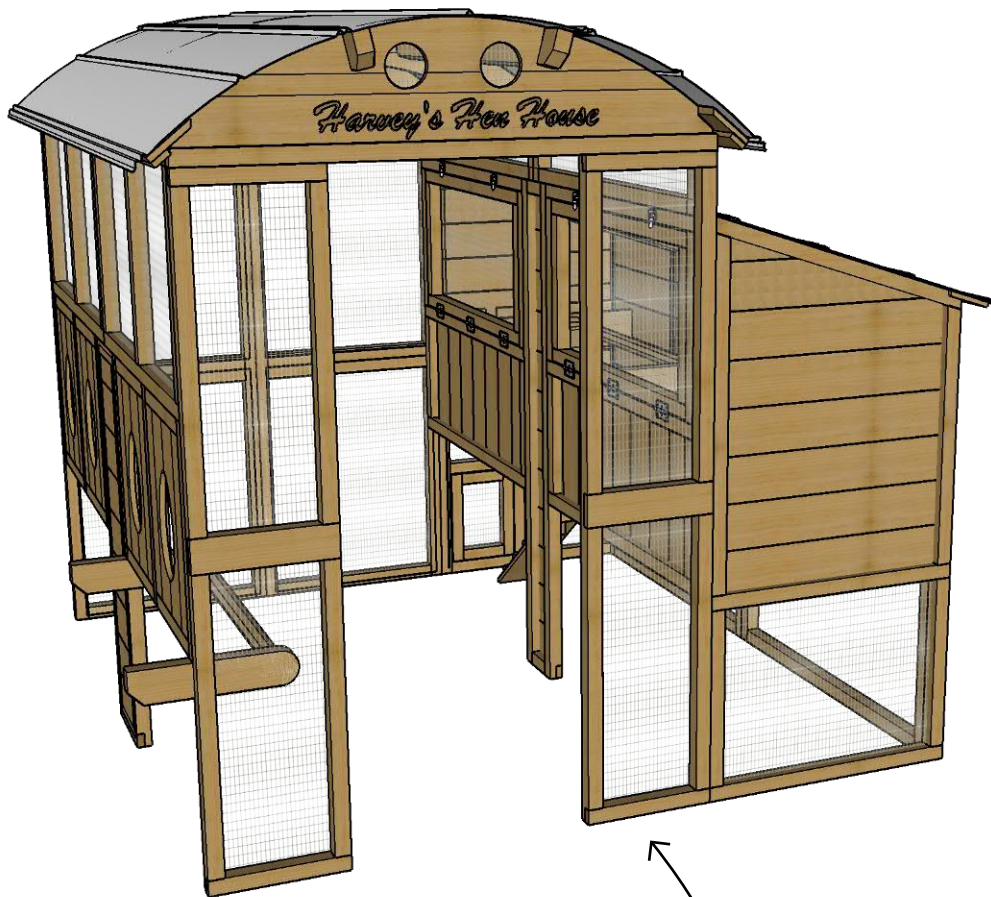

• Standard Coop View...

Section 2

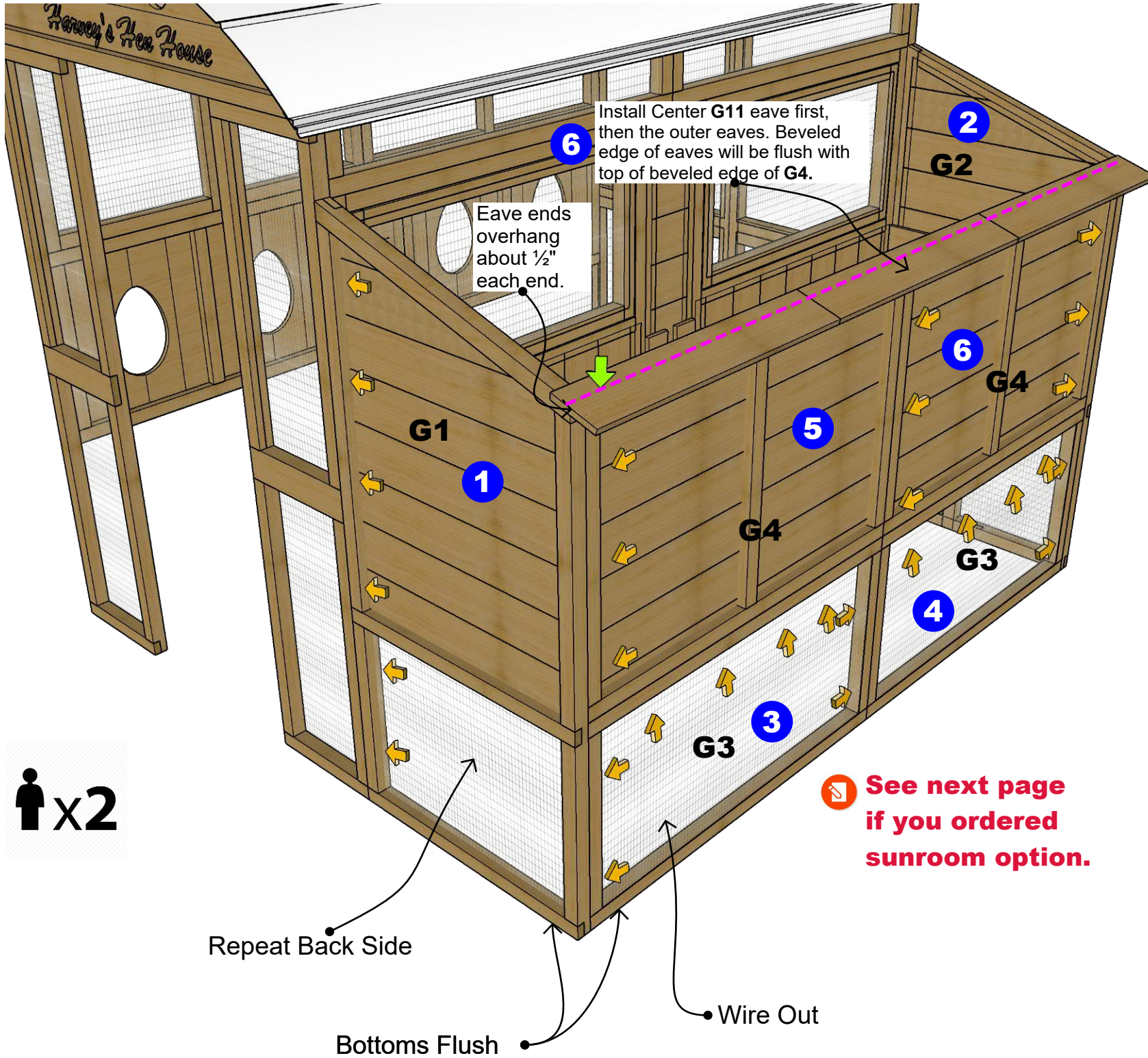

Install Center G11 eave first, then the outer eaves. Beveled edge of eaves will be flush with top of beveled edge of G4.

Eave ends overhang about 1/2" each end.

 x2

Repeat Back Side

Bottoms Flush

Wire Out

 See next page if you ordered sunroom option.

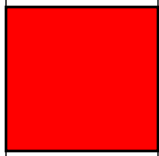

 **Skip Page If You Did Not Order XL Sunroom Option.**

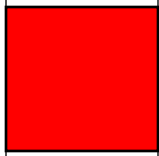
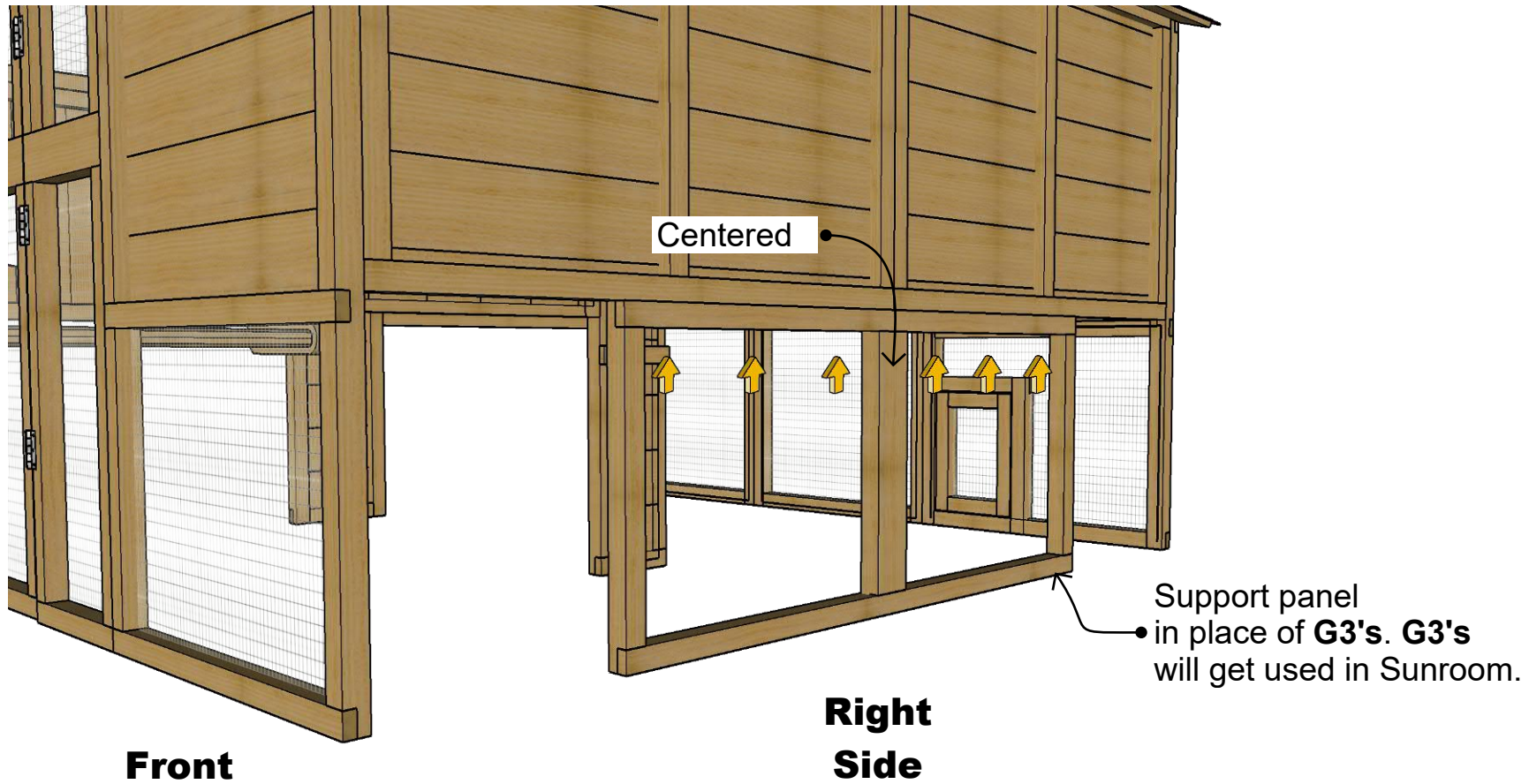



 **See Sun-Room addendum for completion of Sunroom after main coop is completed.**
Illustrated without sunroom option for remainder of instructions.

 Don't over-drive these screws or they may stick out back side.



1/4 T-20 Torx Screws

1 Mount G10 mid roost bar support bracket centered on the back wall 41 3/4 from the very bottom of the coop to the top of the bracket (yellow line). Use 4 of the 1/4 inch T-20 screws in a pattern as illustrated,  taking care to not drive them any deeper than needed to make bracket snug. Drive them too deep and they could poke out the back wall.

2 The G12 roof supports are held in place with 1 of the 3 inch screws in each end. We pre-drill the holes at angles to approximate the angle of the G12 supports. The bottom end of the outer G12's centers on the mid post of the G4 Panels and the middle G12 centers on the middle. See red arrows.  Tops of G12's are flush with the eave tops. Using a helper to hold the G12 steady for you, drive a 3" screw at an angle into the ends of the G12's as illustrated by the gold arrows. 

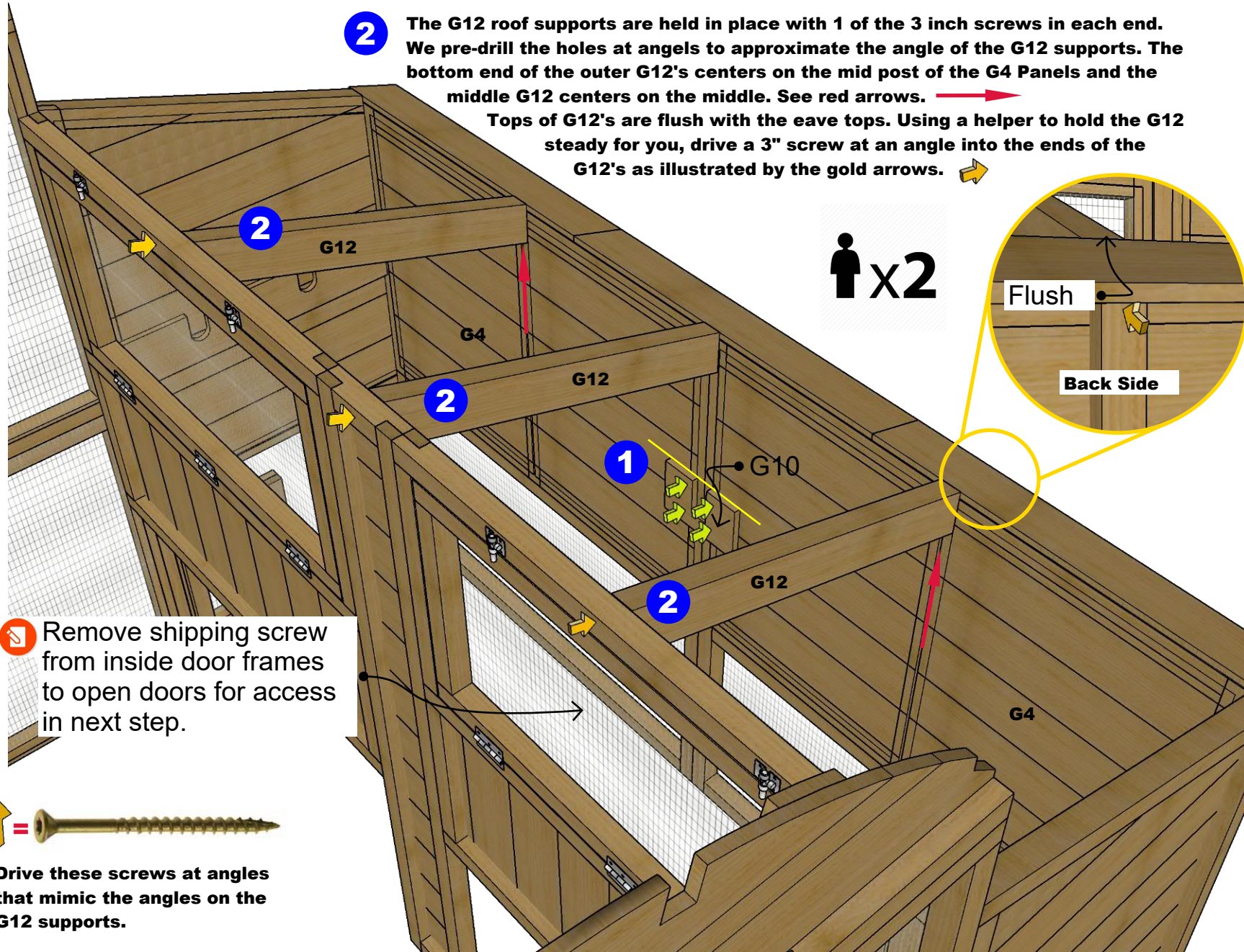

 x2

 Remove shipping screw from inside door frames to open doors for access in next step.



Drive these screws at angles that mimic the angles on the G12 supports.

 Portions omitted for clarity. Looking into back side roost wall.



 Portions of coop walls are omitted for clarity. The roost bars and access ramps are installed through a combination of reaching through the roost access doors, from inside the roost area and standing outside the coop.

3 Place roost bars with notches towards outside and facing up.

2 G9 mid roost support. Screw in from front and back sides.

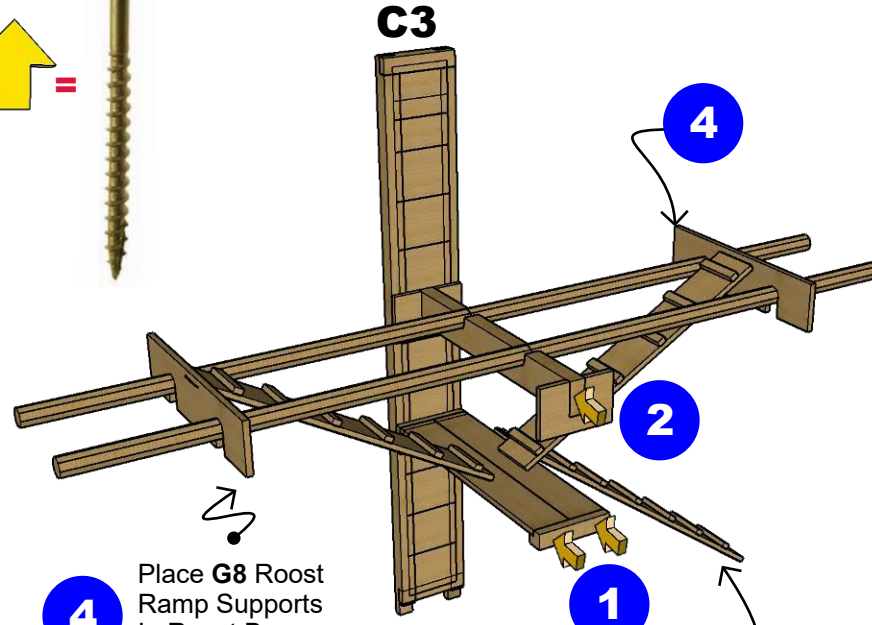
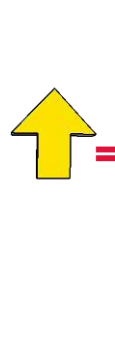

4 Place G8 Roost Ramp Supports In Roost Bar Notches

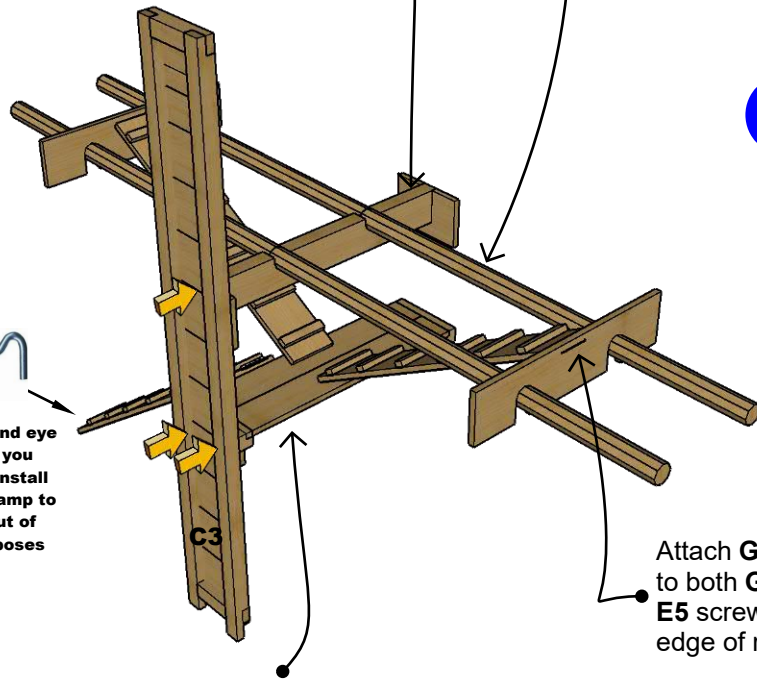

1 G7 Landing rests on support on C3 panel. Screw into place from outside C3 and G3 panels as illustrated.

 An extra hook and eye is included that you may optionally install on the bottom ramp to hold it up and out of the way for purposes of raking.

6 Attach G6 Longer ramp to G7 landing with E5 screws. Either side is fine, towards front is best as its more out of the way of the turnout door.

5 Attach G6 ramps (shorter ones) to both G8 supports with provided E5 screws. Both sides. Bottom edge of ramps rest on G7 landing.

E5 Screw



- 1** Push the TB top back panel up against the side of the coop (C2 panels) and align the pre-drilled holes along the right edge up with the center of the roost back wall, G2 Panel. Loosely screw in upper right corner.
- 2** Push the TF top front panel up against the side of the coop (C2 panels) align the pre-drilled holes along the right edge up with the center of the roost front wall, G1 panel and overlap V-Grooves on the TB panel. Loosely screw in upper left corner.
- 3** Using your drill and the small provided bit, drill through both pieces of roof metal at the indicated positions trying not to drill too deep into the tops of the G12 supports. Double check the alignment of panels and while pushing up against the C2 panels, screw down the remaining 3 spots on the top edge.

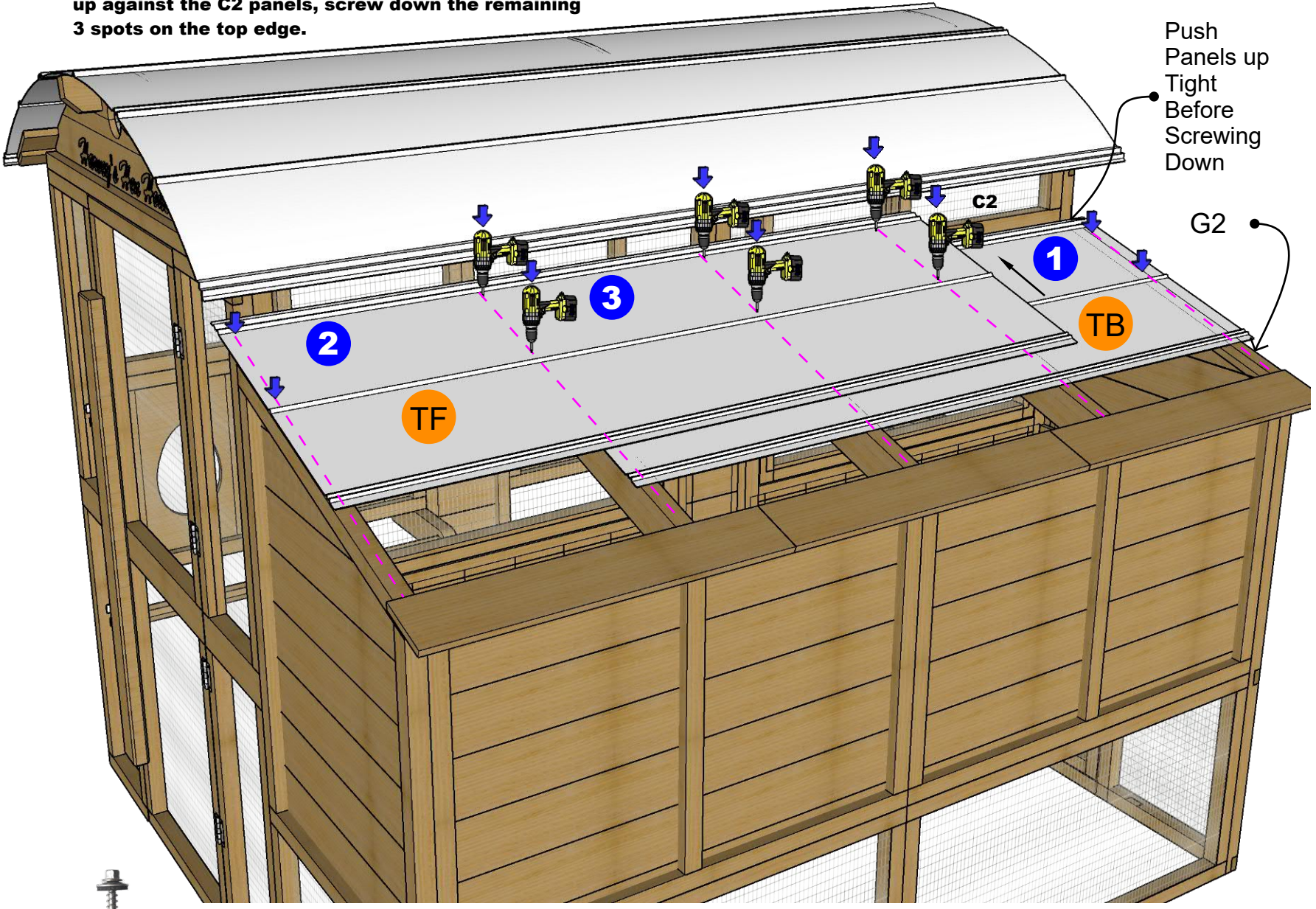

Push Panels up Tight Before Screwing Down

G2

1

TB

2

TF

3

C2

Roof Screw



Tighten only enough to compress rubber washer.



- 1** Slide the BB panel up and under the TB & TF panels until the single "V" in the bottom panel is seated into the 2nd "V" groove of the TB & TF panels. Slide panel side-to-side to where the right edge aligns with edge of TB panel and install bottom right roof screw to pin the BB panel into place. Get panels to lay flat before screwing down.
- 2** Slide the BF panel over top of BB panel up and under the TB & TF panels until the single "V" in the bottom panel is seated into the 2nd "V" groove of the TB & TF panels. Slide panel side-to-side to where the left edge aligns with edge of TF panel and install bottom left roof screw to pin the BF panel into place. Get panels to lay flat before screwing down.
- 3** Using the same drilling and setting of a roof screw learned in previous steps, use the holes in the TF panel to drill into the underneath panel(s) and add a roof screw into each of the positions as illustrated. Tighten all screws firmly, just until the rubber washer is compressed. Try not to crush the rubber washer.

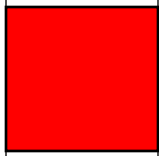
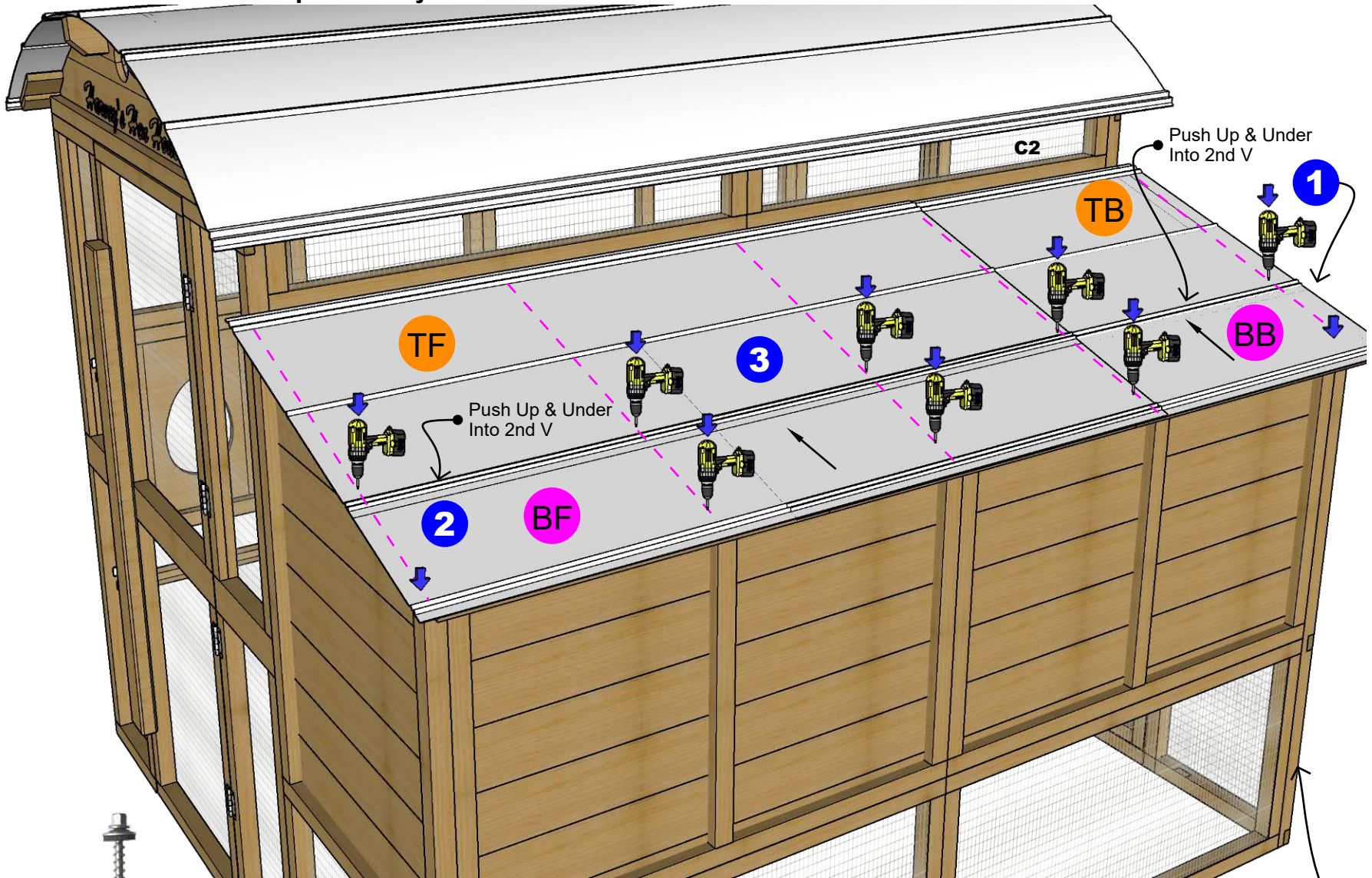

Roof
 Screw

 **Tighten only enough to compress rubber washer.**

G2



Section 3

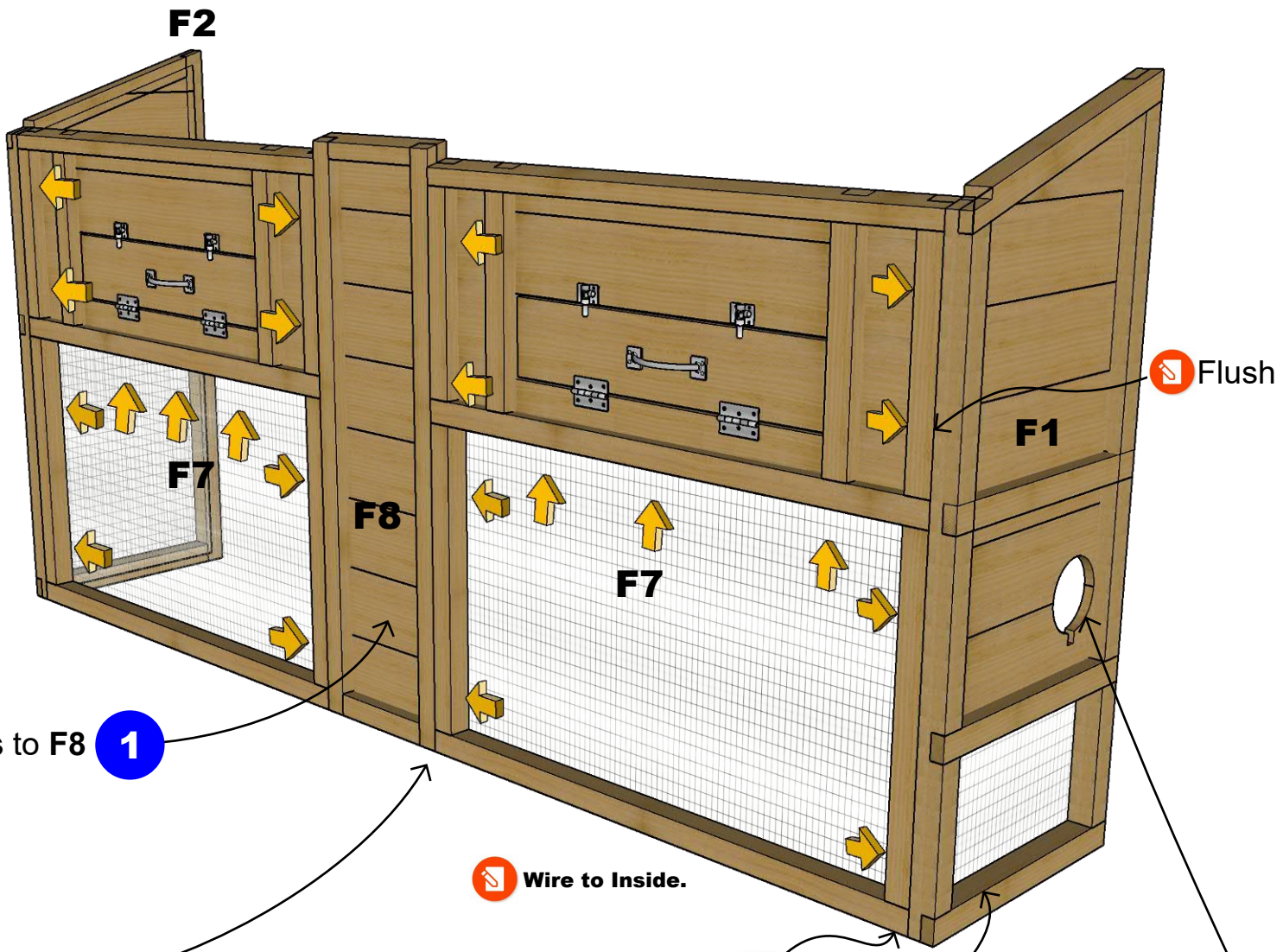
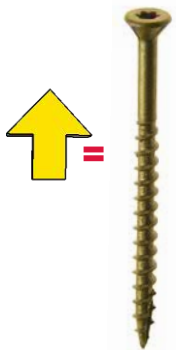

Attach F7's to F8 **1**

Flush Bottoms

Wire to Inside.

Flush

3 Attach F7 to F1 panel, making sure to keep all edges flush. Do the same process for F2.

Cutout for optional waterer
(will have wire over it if you did not get waterer)



1 The F5 panels install at the level as indicated by the purple arrows and attach to the F7 back egg wall door panels as illustrated using the 3 inch T25 screws. The F6 Bottom Feeder Bracket sits between the (2) F5's as shown. Install both F5's and Feeder Bracket before proceeding to step 2. F5's install wire side down.

2 The Day Roost Bars attach under the F5 panels in the positions as indicated with the bars being captured between mirrored brackets. Using the 4" long GRK screws and the T25 torx bit, install a mirrored set of the brackets with the B4 bar captured between the brackets screwing down into the pre-drilled holes in the F5 panels into the B5 Bracket tops. There is a indexing "nick" on the tops of the B5 Brackets for aligning the front to back positioning of the Bracket. About 6 inches of the Bracket sits under the F5 panel.

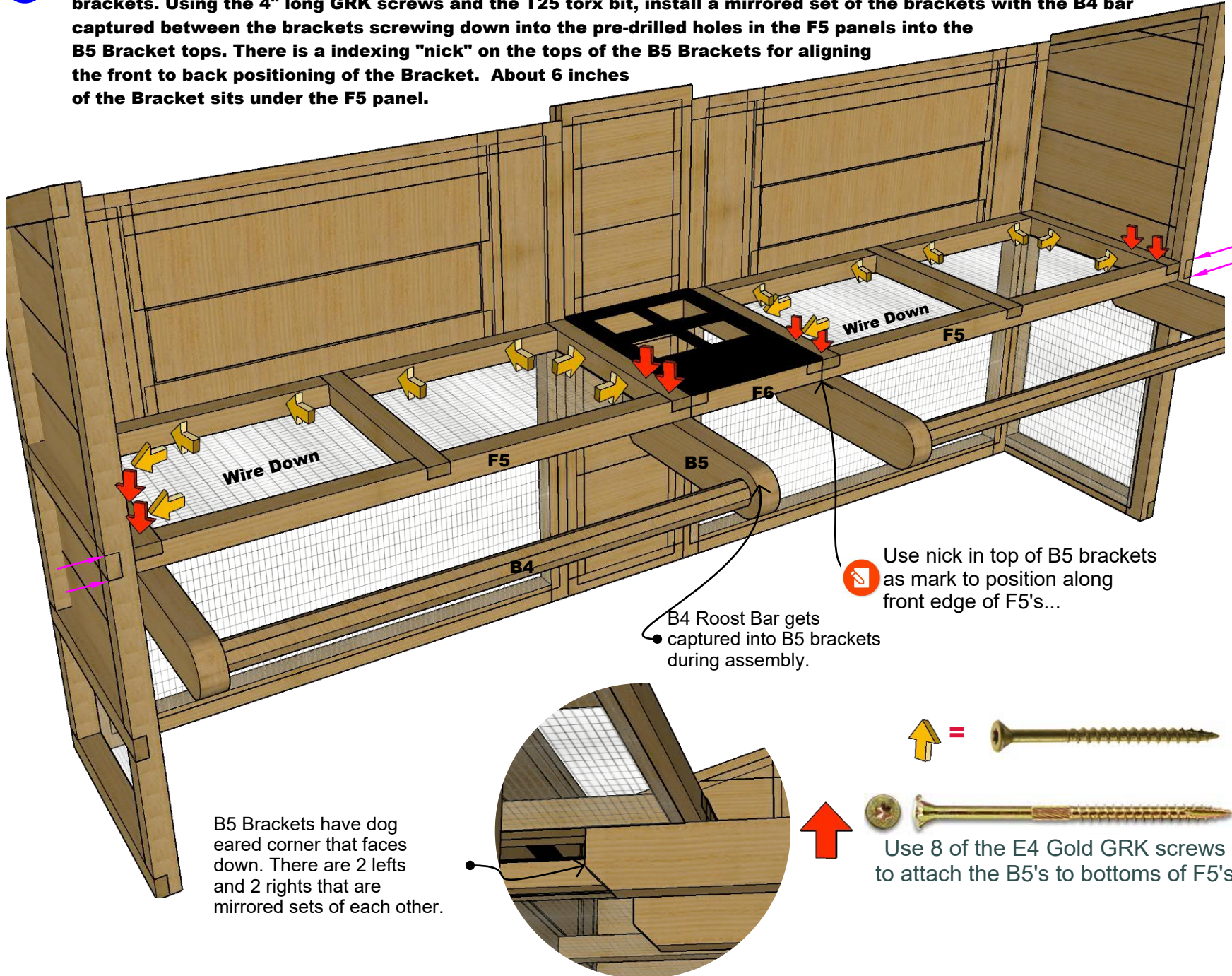

Use nick in top of B5 brackets as mark to position along front edge of F5's...

B4 Roost Bar gets captured into B5 brackets during assembly.

B5 Brackets have dog eared corner that faces down. There are 2 lefts and 2 rights that are mirrored sets of each other.

Use 8 of the E4 Gold GRK screws to attach the B5's to bottoms of F5's



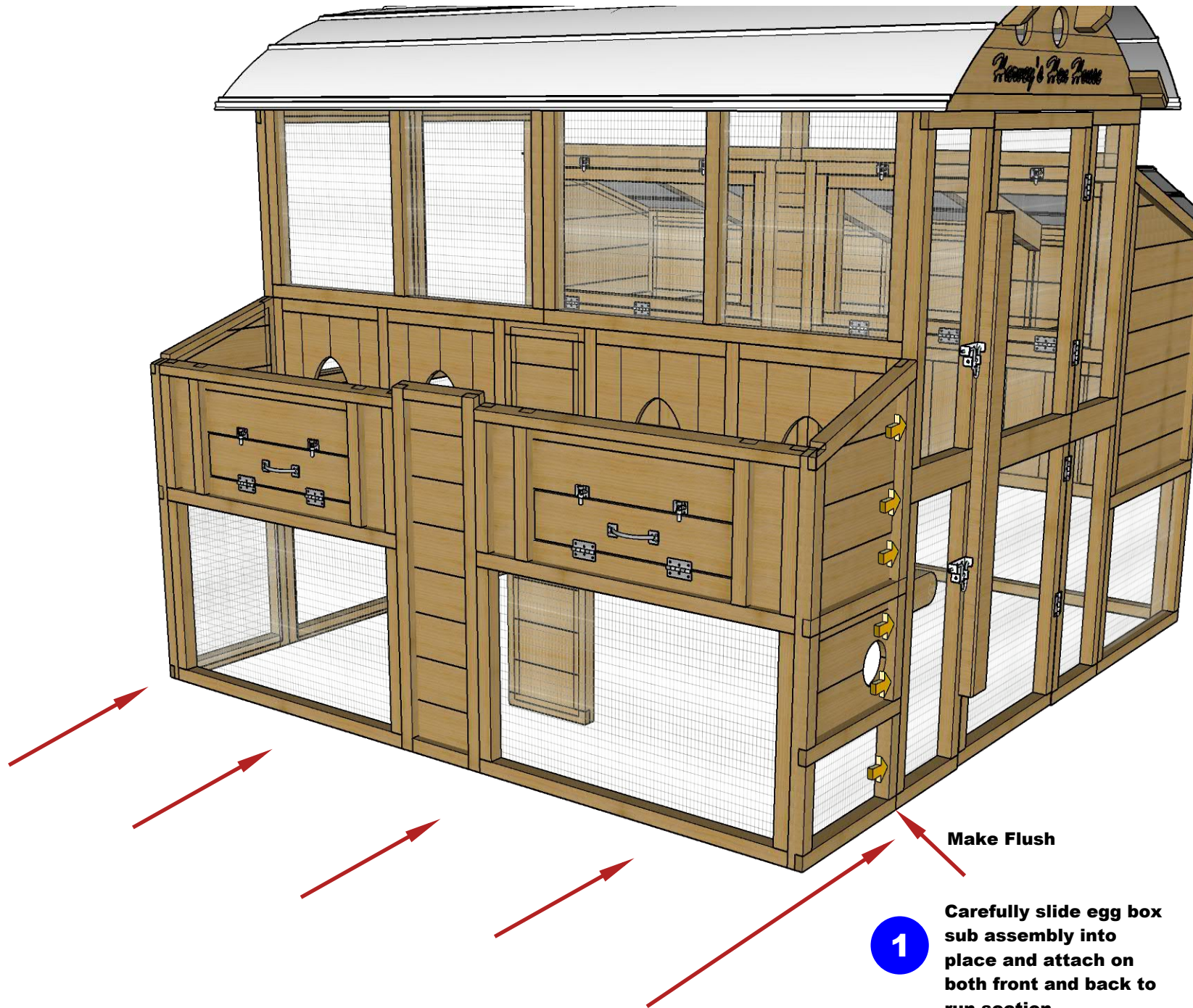

1

Carefully slide egg box sub assembly into place and attach on both front and back to run section.

Make Flush

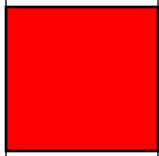

1

The two F3 Outer Dividers are interchangeable whereas the two F4 Inner Dividers are mirrored copies of each other and have a left and a right side. Dividers are dropped down into egg box (force fit may be required) and screwed into place using 3" T25 and 1 5/8 T20 screws as indicated by corresponding arrows. Back edge sticks up slightly higher to accommodate eave in next step.

3

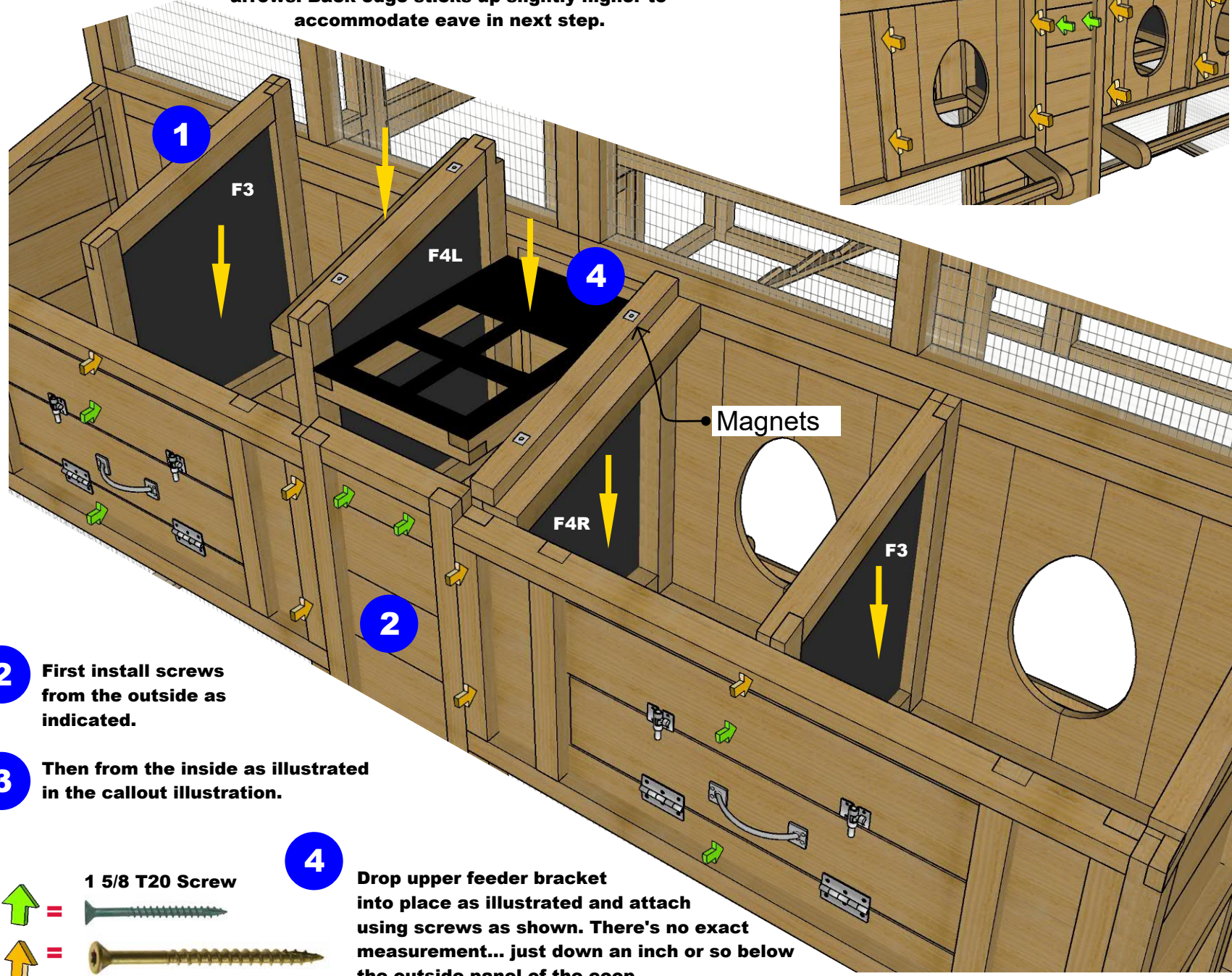
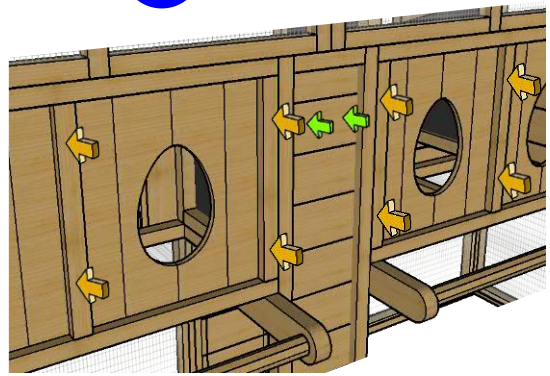

2

First install screws from the outside as indicated.

3

Then from the inside as illustrated in the callout illustration.

4

Drop upper feeder bracket into place as illustrated and attach using screws as shown. There's no exact measurement... just down an inch or so below the outside panel of the coop.

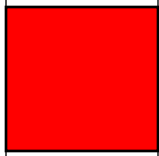

Install optional water brackets & feeders. Panels hidden for clarity.

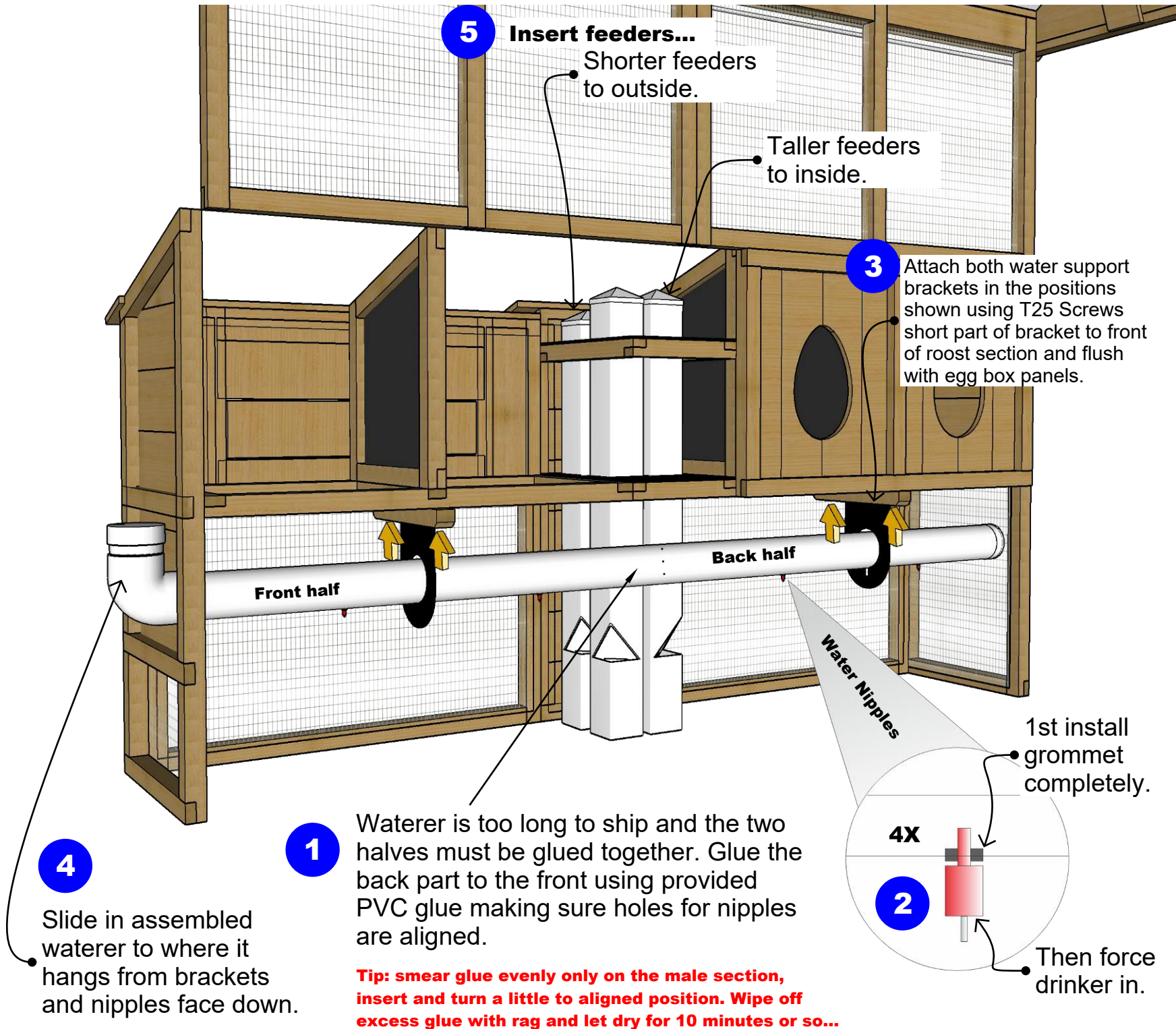

5 Insert feeders...
Shorter feeders to outside.
Taller feeders to inside.

3 Attach both water support brackets in the positions shown using T25 Screws short part of bracket to front of roost section and flush with egg box panels.

1 Waterer is too long to ship and the two halves must be glued together. Glue the back part to the front using provided PVC glue making sure holes for nipples are aligned.

Tip: smear glue evenly only on the male section, insert and turn a little to aligned position. Wipe off excess glue with rag and let dry for 10 minutes or so...

4 Slide in assembled waterer to where it hangs from brackets and nipples face down.

2 1st install grommet completely.
4X
Then force drinker in.



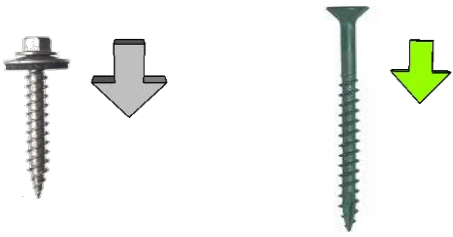

Lipped
Edge Out

Folded Edges
To Inside

F11

F12

F9

F10

F11

F12 panel covers
feeders and is
held in place by
magnets.

Force up against
edge of coop.

1

Screw in place with back edge flush
the 2 F3 outer eave boards and the
inner F3 eave boards. Make sure
magnets in F10 face up.

2

Screw down both F9 outer roof
panels with folded lip to the inside
using roof screws as indicated.
Make sure you are screwing into
the supports.

Align latch carefully and use at least 2-3 screws and tighten.

2

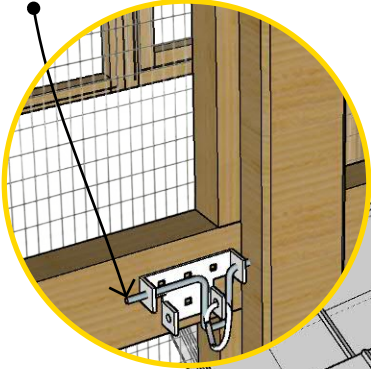

Use large pan head screws to install gate latch where pin slides freely into and releases freely from catch hole in door handle.

2

Pre-Drill holes if needed.

Large Pan Head Screw



4

An extra hook and eye set is provided if you want to install inside of coop.

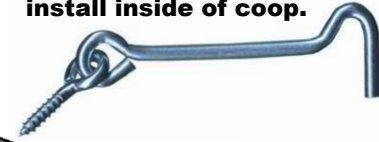

Install hinges in predrilled holes using flat head Philips Screws.

1

Bit



Flat Head Screw



1 Find shipping screw in door frame that keeps door closed during transport and remove it.

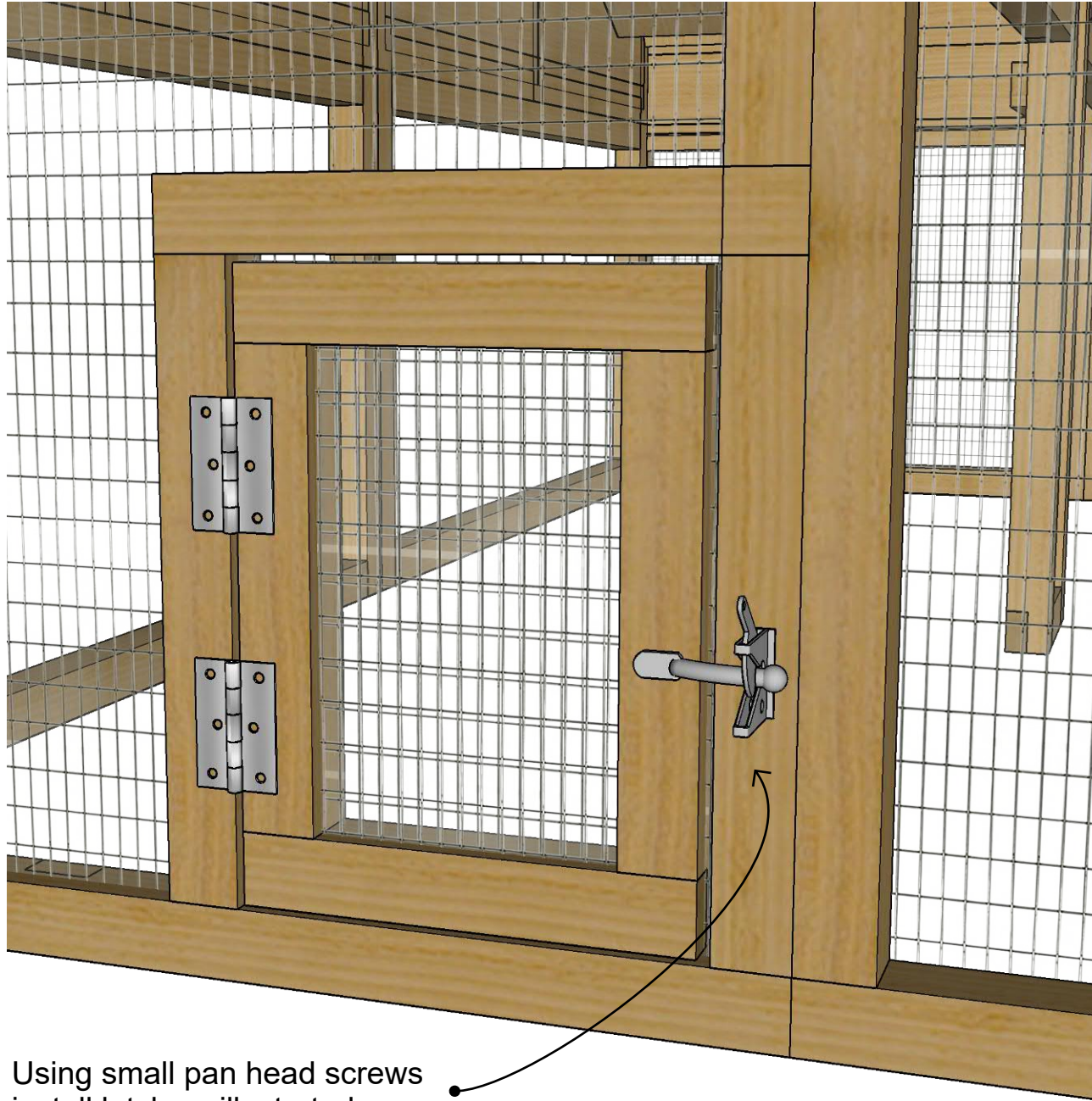

2

Using small pan head screws install latch as illustrated.



Small Pan Head Screw

Some things to know about using your new Round-Top Walk-In™ Chicken Coop

Egg Box Liners: You will need to put some sort of a liner in the bottom of the egg boxes. We recommend a cut up doormat that can be washed. An egg might get broken or some chickens will prefer sleeping in the egg boxes at times, and a liner makes it easy to wash. The egg boxes being dark is what makes a chicken lay there versus somewhere else.

Optional Waterer: If you bought the waterer, you will need to rotate it downward to dump the water and then the nipples can fit through the keyhole on the top of the entry cutout. Dump into a bucket if you don't want the ground getting wet. We do this to protect the nipples and the brackets from the weight of the waterer when full.

Freeze Guard Nipples: If you have the optional Freeze Guard Nipples, they must be removed to completely remove the waterer.

Digging Predators: Due to varied terrain around the country, we do not propose only one method of protecting from digging predators. Call if you have questions and we can help you decide on the best method if it is something you are concerned about. We have great articles on this topic in the blog section of our website.

If You Ordered The Feeders: Feed may clog in very damp climates or when using feeds that do not have clumping agents. Usually, shaking the feeder will dislodge clogged feed. If persistent, the angled chute in the feeder can have some of the material removed from the exit opening...a little at a time until you achieve the performance you want.

Storm Panels: The Walk-In Coop™ comes stock with 2 storm panels for the roost doors. In places where there is a lot of snow or consistent sub-zero wind chill, a complete set can be ordered as an option. "Clips" on optional set require installation by the consumer to protect them during shipping.

See our web site for options to keep water from freezing in the optional waterer.

MADE IN 

roost&root[®]

Find your inner farmer.[™]

Start Here!



Help Hotline: 877-741-2667

or info@roostandroot.com re: Assembly Support

Assembly Drawings

SKU 732

Round-Top Walk-In[™]

Sun Room

Addendum to
Full Instruction
Set

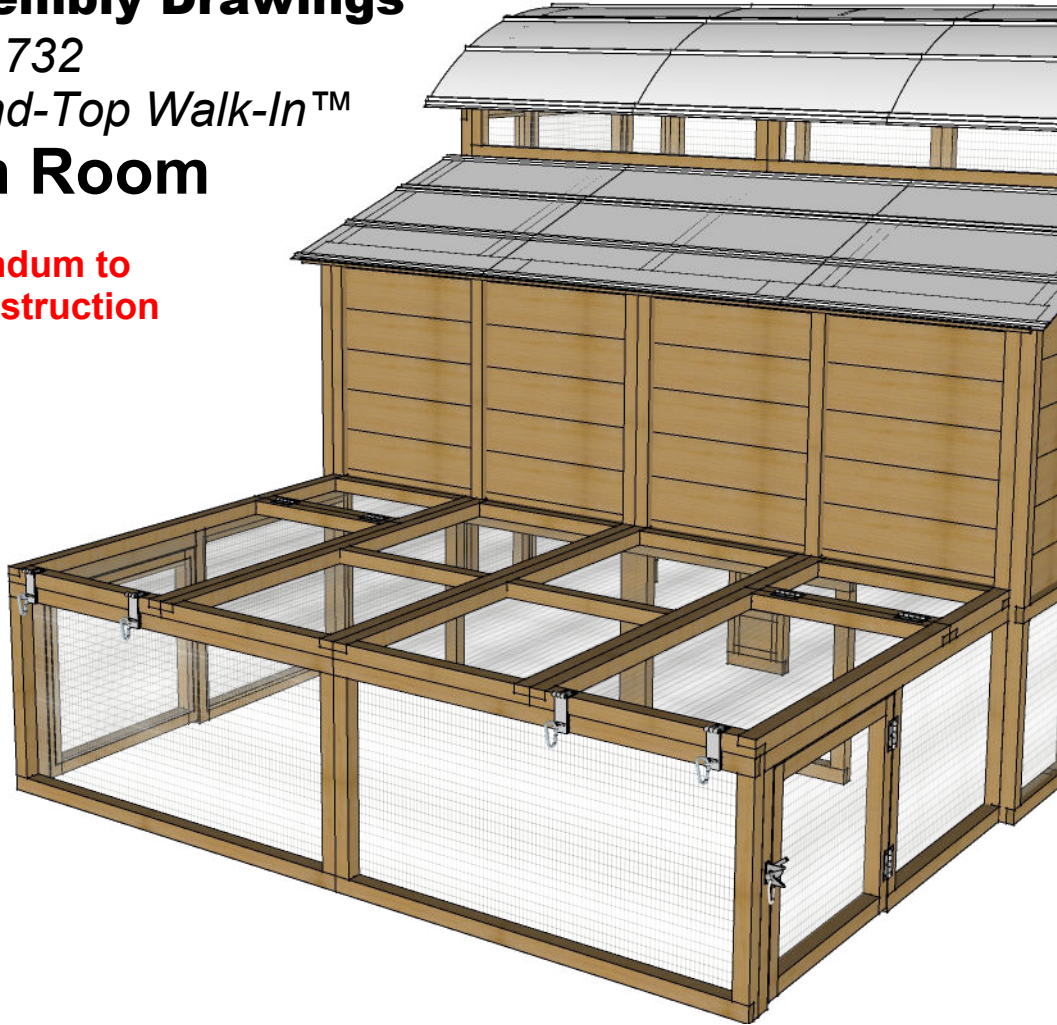

Some things you should know...

Understanding these concepts / conventions will help guide you through the instructions.

- Mating edges of parts to be flush and tight (when called for) will keep measurements in tolerance as the coop grows in size.
- You will need a drill (preferably cordless) and a tape measure will be helpful. Everything else is provided.
- Drive screws only deep enough to hold parts tight and not bury the heads too deeply as water will sit in the divots and it may cause softening of the wood and prematurely loosen screws. It will also greatly decrease your ability to easily disassemble a part if needed.
- You may end up directly driving in a screw. The brown and green screws are very aggressive and will drive with no pre-drilled hole. Keep screw entry points in the meat of the wood and not too close to edges. Screws in knots or close to edges should be pre-drilled.
- Rough Cedar may have knots, cracks or frays that are normal. We cull and cut around most imperfections we deem structurally problematic during fabrication. If you get a piece that you feel is not beautiful, please let us know so we can address your concern.
- We hand fabricated your coop with human carpenters. We work really hard to not make mistakes. In the rare occasion that we either misfabricated a part, a part was damaged in shipping, or we forgot to package a needed part, contact us and we will ship out a replacement part for you at no cost.
- We recommend dirt floors in the runs of coops. A trimmed rubber mat or turf mat can be placed in the bottom of egg boxes, or you may wish to put pine shavings them. They are left wired so they can be cleaned in the event of a broken egg.

V1

Fall 2022

Copyright © Roost & Root, all rights reserved. Do not copy or distribute without written permission of Roost & Root. We claim all available Federal protection for the name Round-Top Coop[™], our protected designs and trade dress as is allowed by any and all Federal intellectual property protection laws. We invest heavily in our coops and work very hard to design our products and will defend their ownership. These instructions are for the sole use of Urban Coop Company customers.

Front (these orientation references coincide with the Walk-In Main Coop)

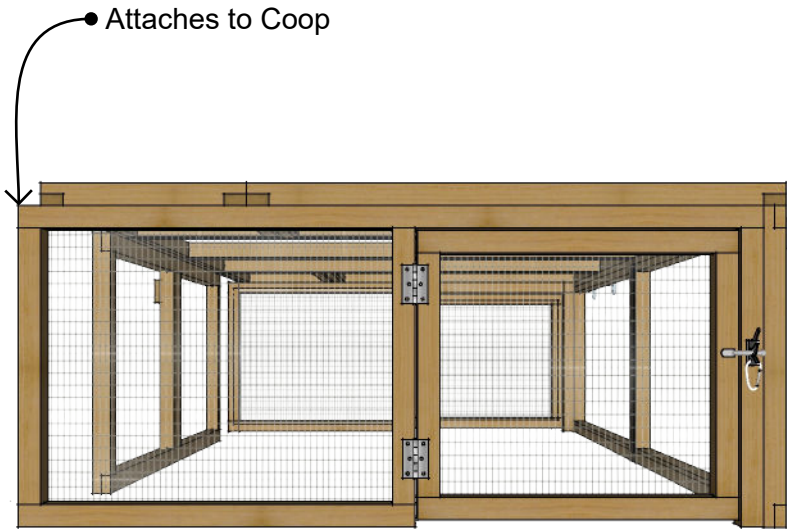

Left

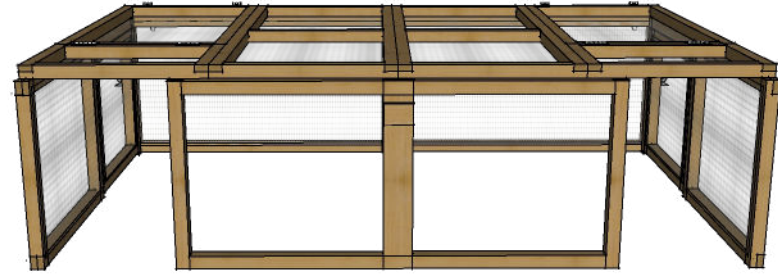

Back

Attaches to Coop

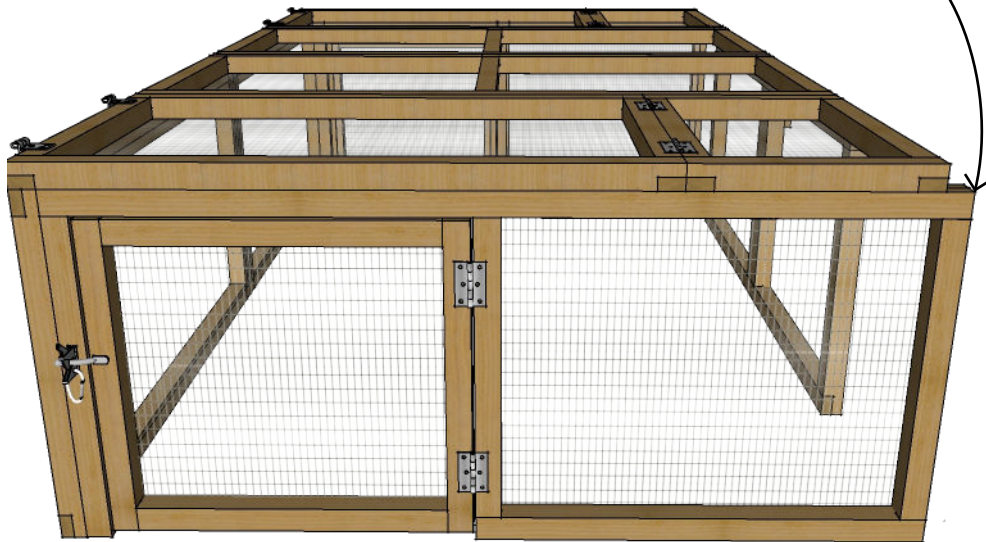

Top

Right

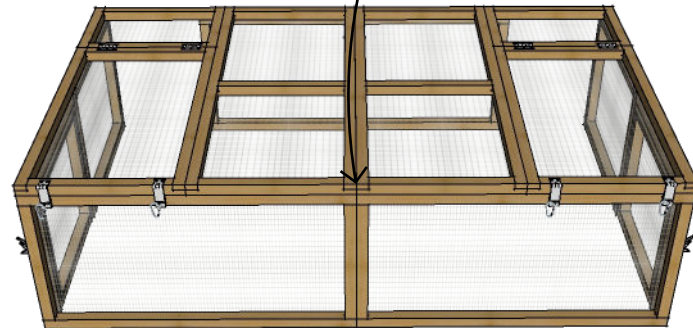

Written Parts List

I. Run Panels

- I1 Support Panel
- I2 Front Panel
- I3 Back Panel
- I4 Right Panel (Qty 2)

Note: I4 & G9 Panels are the same and if you already own a coop and did not buy the Sunroom at the same time you bought your coop you will remove your G9 panels and use them as I4's as indicated in these instructions. It may take several years for all the wood to patina to the same gray...but it will.

- I5 Top Door Panels (Qty 2)
- I6 Top Mid Panels (Qty 2)
- I7 Hasp & Clip (Qty 4)
- I8 Door Latch & Clip (Qty 2)

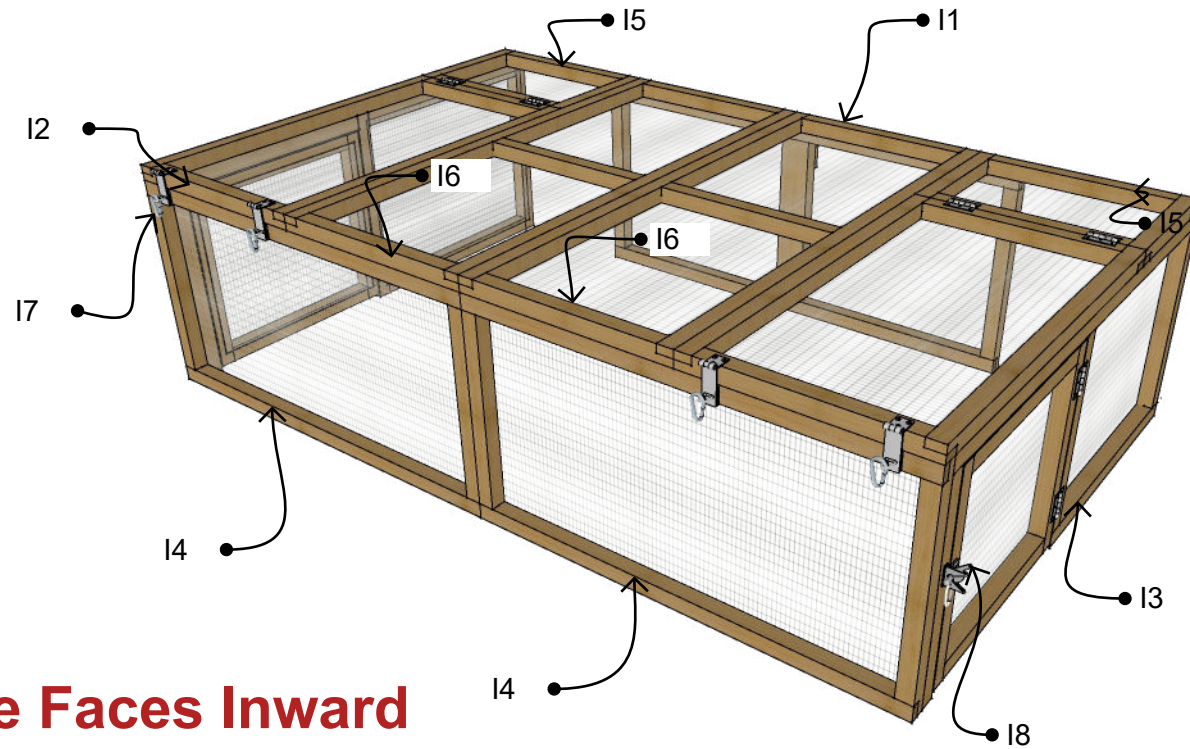

Wire Side Faces Inward



More about your Roost & Root product!

Care:

You can seal your coop if you wish. You should use a low VOC water based product. You can have color added to these products too...like painting, but its a wood stain that lets the wood breathe. We recommend color sealing rather than painting. You paid a premium price for your coop in part to pay for the cedar. It will last outdoors in its natural state for many years, better than almost any other wood. Sealing can keep the wood from going grey. That's the main benefit. Clean wood with mild detergent and water or with a commercially available coop cleaner as needed. Glues used in all joints are completely waterproof and all metal parts are galvanized or have exterior rated coatings.

Placement:

Easy access to water/feed and clear access to doors is needed. Sunlight is not all bad, and the Galvalume roof does a good job at not transferring heat and provides shade. Sunlight does a good job at disinfecting the ground under the coop. Fifty percent (50%) or more of direct sun is preferred. Good air movement around your coop is more important than anything else. The back side should be faced North if at all possible. Remember... High ground is dry ground. **For coop doors to open easily over time, the coop must be level.**

Digging Predators:

The welded wire and cedar frames are stronger than almost any predator less than a bear :) so diggers are the prime nuisance. By far dogs are the most common digger. Other "wild" animals, while more rare, certainly can dig too. If you're worried about diggers, stack heavy block shaped rocks around perimeter of coop to make getting under more difficult. Better yet, bury them around the perimeter just below grade. You can also attach a strip of wire that extends out from the bottom rails, and bury below the surface of the soil. We recommend dirt in bottom of coops that has good drainage. Pine shavings, straw or shredded junk mail can be used in laying areas... but is not recommended in the main run areas.

More About Cedar:

Your coop is built from rough cut Appearance Grade North American Western Red Cedar. Our 2x2's are actually custom milled by Weyerhaeuser. Wood deemed defective is culled during milling, cutting and in fabrication... about 5%-10%. Knots, blemishes, fraying, coloring variations, minor surface cracking, slight warping and periodic worm marks are normal parts of rough cedar. We try to make it to where a reversible part always has a "pretty side" and take care to make the "pretty side" show on all parts. If you're unhappy with a piece of wood we fabricated into your coop, send us a picture. We want you to love every piece of your new coop.

MADE IN USA
roost&root
Find your inner farmer.™

Assembly Instructions
SKU 732 Walk-In Sun Room
V2 Fall 2022

Copyright © Roost & Root all rights reserved.

Parts List

Fig 1

Please Note: If you are retrofitting the Sunroom onto an existing coop these 2 panels are the G9's from your current coop and the I1 support panel provided is installed in place of the G9's on your coop to support roost. You must remove the G9's by unscrewing them and then putting in their place the I1.

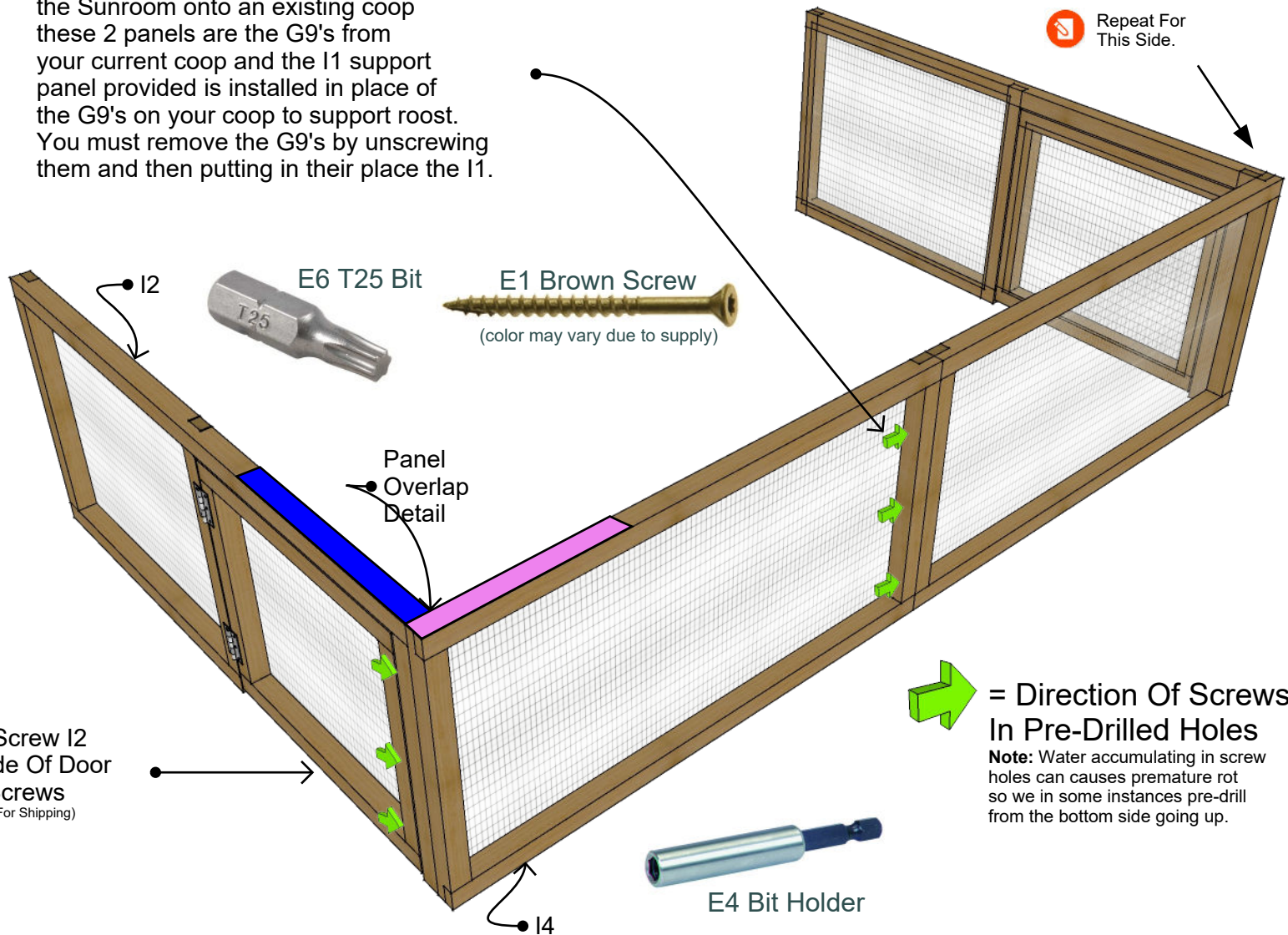

Open Door And Screw I2 Into I4 From Inside Of Door Frame To Hide Screws (Door Held In Place By Screw For Shipping)

Green Arrow = Direction Of Screws In Pre-Drilled Holes
Note: Water accumulating in screw holes can causes premature rot so we in some instances pre-drill from the bottom side going up.

:-) Here we go !

1.1 Build Sides - Fig 1 Using **E6 T25 Bit** in **E4 Bit Holder** in your drill, drive **E1 Brown Screws** into pre-drilled holes as indicated by Green Arrows attaching **I2 Panels** (both sides) to **I4 Panels** (G9 Panels if from your existing coop) making sure all edges are flush.

Note: Only drive screws deep enough to hold and try not to bury heads too deeply into the wood.

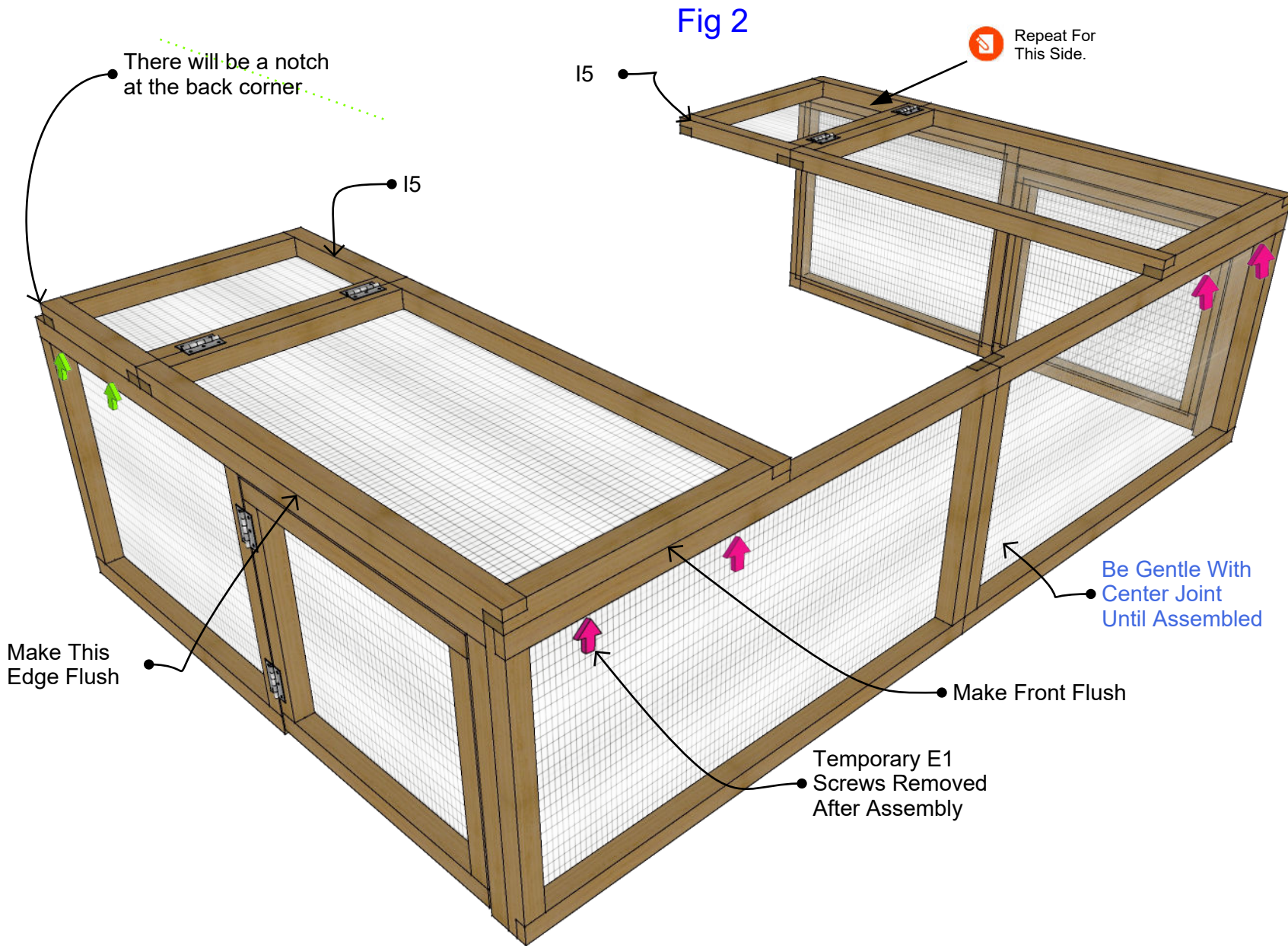

Time to top it off...

2.1 Attach Outer Tops- Fig 2 Using **E1 Brown Screws** attach the 2 **15 Outer Tops** as illustrated permanently installing screws in the positions indicated by the green arrows and temporarily affixing the front edge of the panel where indicated by the two purple arrows. Repeat for other side.

Align edges where they are flush so that the corner is square...

Carefully Move Into Position With 2 People

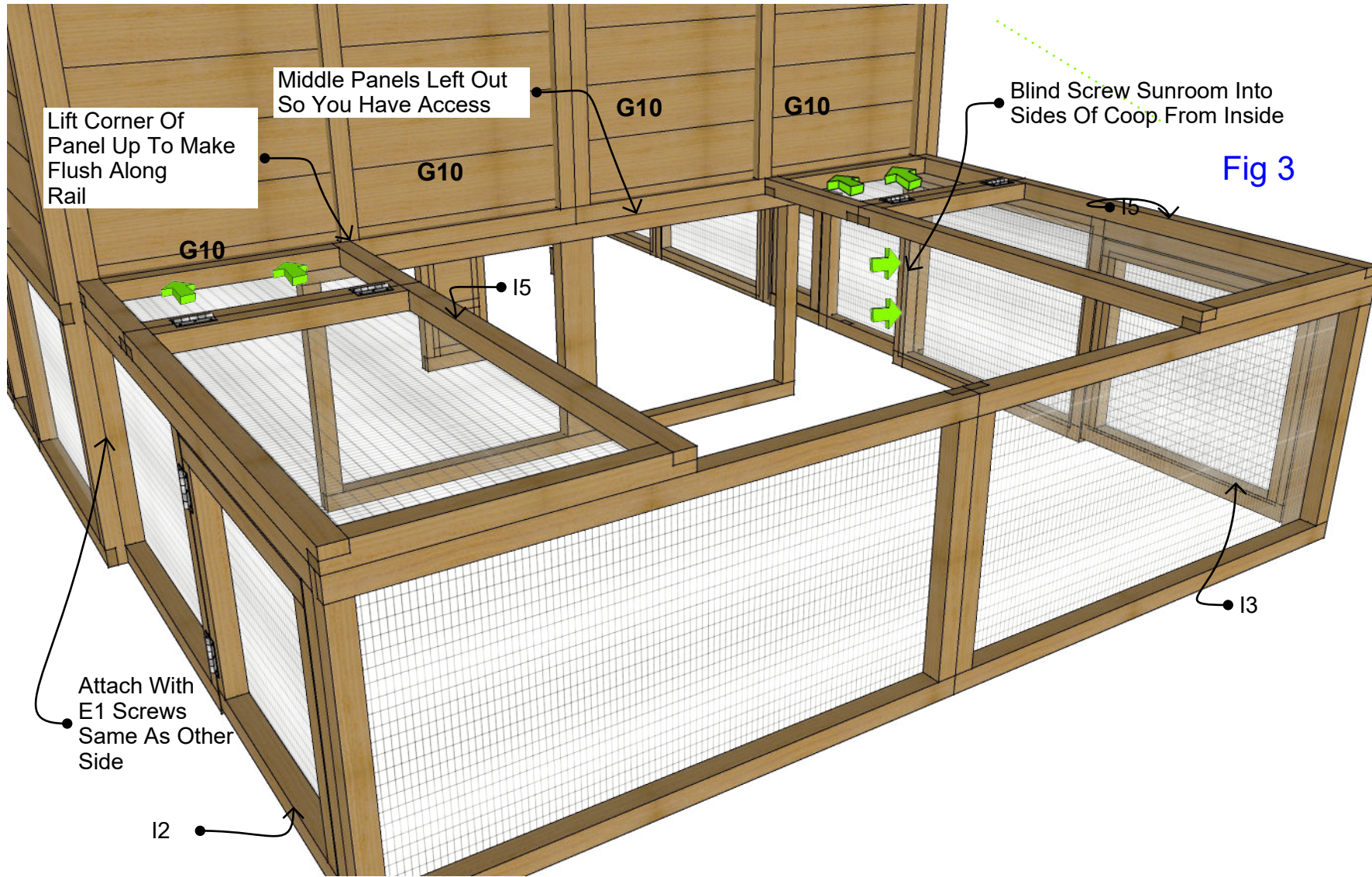

Lets hook it up...

3.1 Attach Sunroom- Fig 3 With 2 people, carefully position sunroom assembly onto roost side of coop using **E1 Brown Screws** into pre-drilled holes as indicated by Green Arrows attaching the **I2 & I3 Panels** from the inside of the coop (if you cant bend down from the outside is fine too) and affixing the **I5 Panels** to the bottom sides of the **G10** panels making sure all edges are flush. Repeat for both sides.

Note: Only drive screws deep enough to hold and try not to bury heads too deeply into the wood.

MADE IN USA
roost&root
Find your inner farmer.™

Assembly Instructions
SKU 732 Walk-In Sun Room
V2 Fall 2022

Copyright © Roost & Root all rights reserved.

Attach To Coop

Step 3

If needed, gain access to these screws by flipping up top doors and standing inside run.

Images Are Illustrative. Your Latch Hardware May Look Slightly Different.

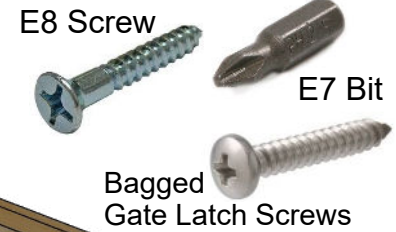

Fig 4.1

Remove Temporary Screws Both Sides To Open Access Door

• 16 Mid Top Panels

Da dahhhh !

4.1 Install Middle Tops - Fig 4.1 Using E1 Brown Screws attach 2 I6 Middle Top Panels as indicated by Green Arrows.

4.2 Door Hasps - Fig 4.2 Using E8 8 Screws attach the 4 Hasps as illustrated in Fig 4.2 in positions as indicated in Fig 4.1.

4.3 Gate Latches - Fig 4.3 Using bagged gate latch screws, attach the 2 latches as illustrated in Fig 4.3 onto the to side access doors in positions as indicated in Fig 4.1.

Keep Safety Clips in place at all times to keep latches securely fastened.

Fig 4.2

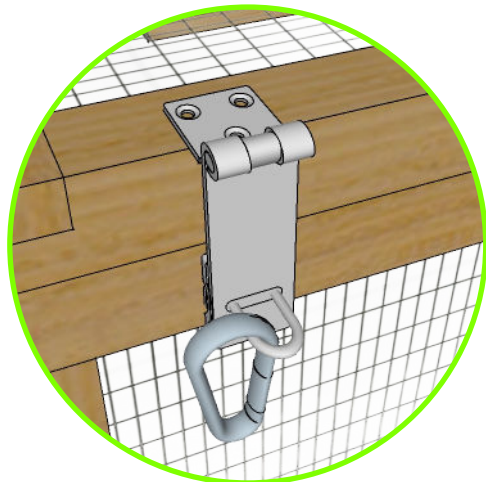

Fig 4.3

